

NAV-TV

INTERFACING THE FUTURE

3950 NW 120th Ave, Coral Springs, FL 33065 TEL 561-955-9770 FAX 561-955-9760

www.nav-tv.com info@nav-tv.com

BHM
12/24/14
NTV-DOC143
rB6

BMW12-DYNAMIC KIT

NTV-KIT462



Overview

The BMW12 kit allows the user to add up to 3 video inputs and a backup camera input to the factory media screen in select BMWs. This interface generates steering-based guidelines while in reverse for added convenience.

Kit Contents



AV Input Harness



BMW12 Interface



LVDS Video cable

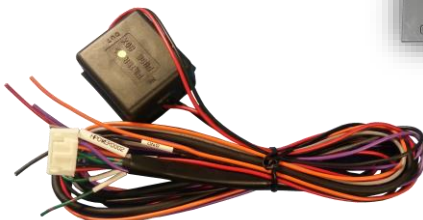

Power/CAN Harness (non P&P)



Remote



IR Eye
Harness

Input
Toggle
Switch

Plug & Play Kit ONLY



Plug & Play T-Harness

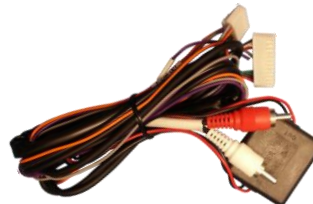

Power/CAN Harness

Agreement: End user agrees to use this product in compliance with all State and Federal laws. NAV-TV Corp. would not be held liable for misuse of its product. If you do not agree, please discontinue use immediately and return product to place of purchase. This product is intended for off-road use and passenger entertainment only.

Interface Connectors

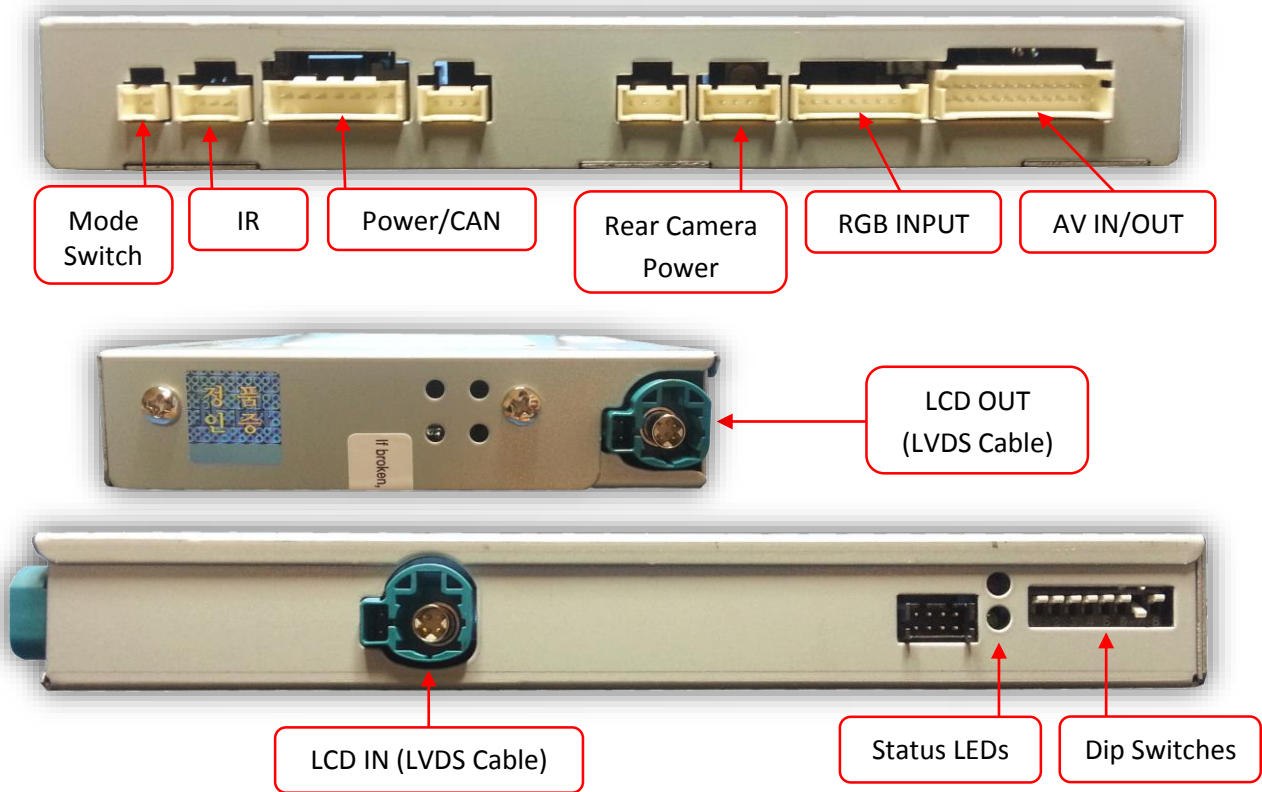

Typical dip switch settings*

Dip SW:	1	2	3	4	5	6	7	8
UP	Enables RGB	Enables V1	Enables V2	Enables V3	8.8"/10.2" Screen	N/A	Deactivates Rev-Cam	N/A
DOWN	Skips RGB	Skips V1	Skips V2	Skips V3	6.5" Screen	N/A	Activates Rev-Cam	N/A

Below are dip switch settings for ALPINE-built screens ONLY.

Dip SW:	1	2	3	4	5	6	7	8
UP	Enables RGB	Enables V1	Enables V2	Enables V3				X
DOWN	Skips RGB	Skips V1	Skips V2	Skips V3	X	X	X	



***Note: after adjusting Dip Switches, you must disconnect and reconnect power to the interface or the change will not be implemented.**

Quick Connection Guide

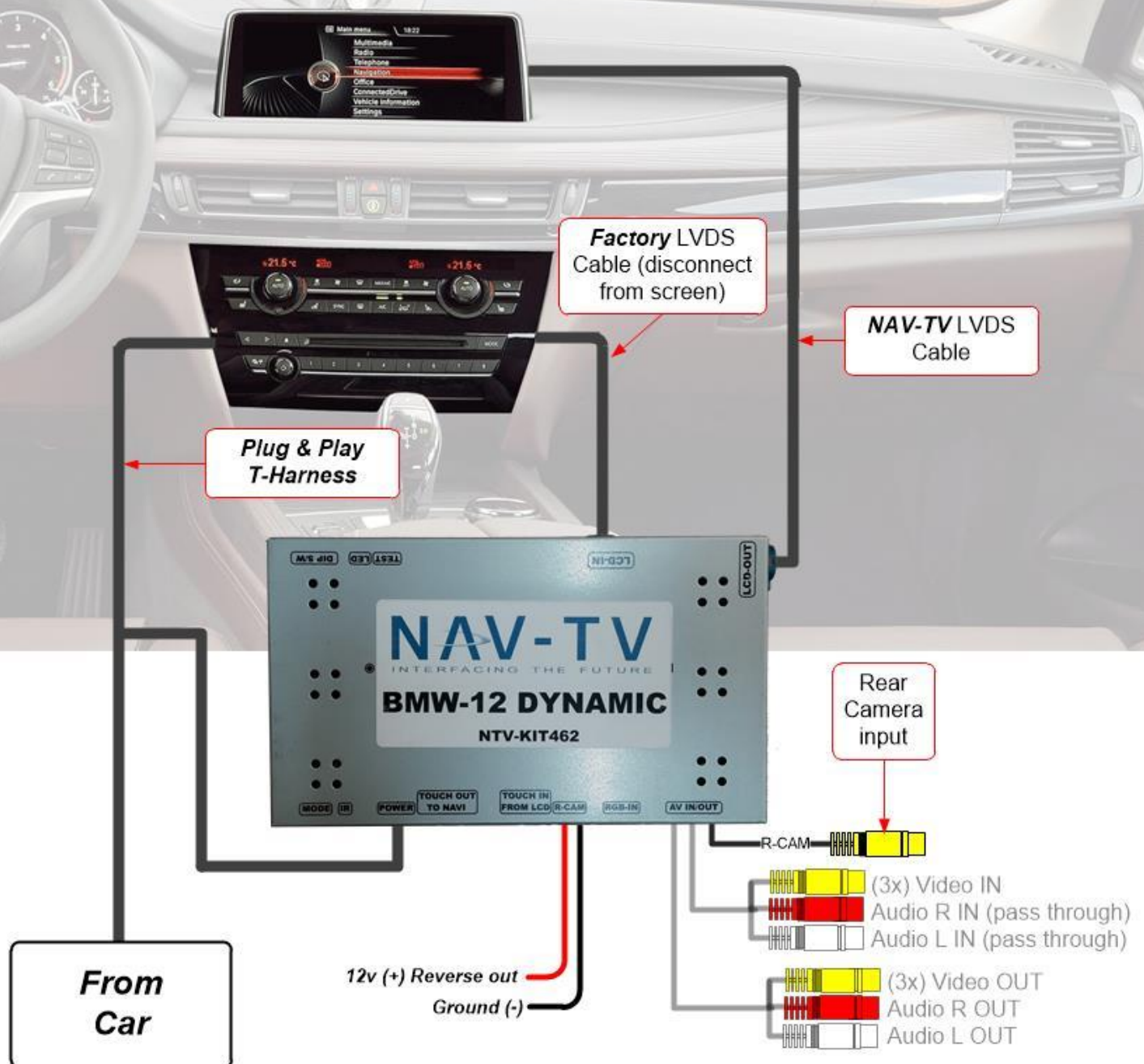

- Provided interface video cable (LVDS) from BMW12 interface connects directly to **OEM monitor**
- CAN and POWER connection is made **behind radio** (plug & play or manual wire)
- If using Plug & Play, fiber optics must be removed (from OEM) and inserted into T-Harness
- Audio input is **pass through only**

Agreement: End user agrees to use this product in compliance with all State and Federal laws. NAV-TV Corp. would not be held liable for misuse of its product. If you do not agree, please discontinue use immediately and return product to place of purchase. This product is intended for off-road use and passenger entertainment only.

Dash Disassembly (5 series)

1. Begin by removing the trim which surrounds the center vents and extends over the glove box with a plastic tool. There should be no screws securing this panel.



2. Disconnect all harness connected to this panel (near the vents mostly). You may want to remove the push button ignition switch so that you can test the BMW12 interface prior to replacing the dash panels. Either unclip this assembly or remove (3x) Torx screws and then reconnect to the vehicle plug:

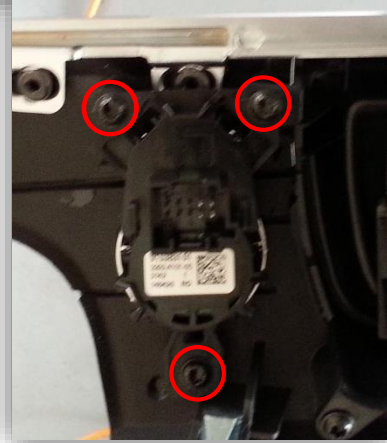

3. Remove (2x) Torx screws securing the radio controls and climate control face, pry outwards and disconnect all harnesses:



4. You should now see the disc-player portion of the radio. Remove this assembly by removing (2x) more Torx screws:

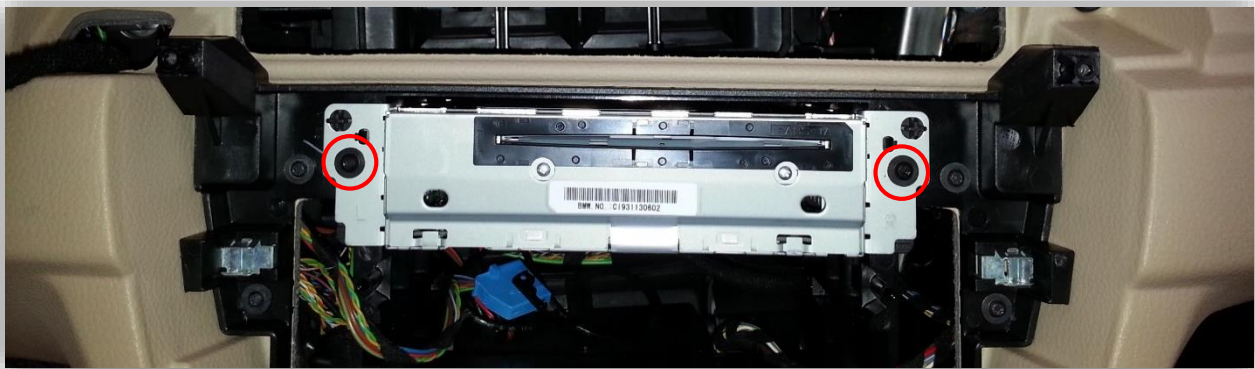

5. Remove the factory radio by pulling it straight out, towards you. Disconnect all connectors. These single-din radios (5 series and others) have the following connectors:

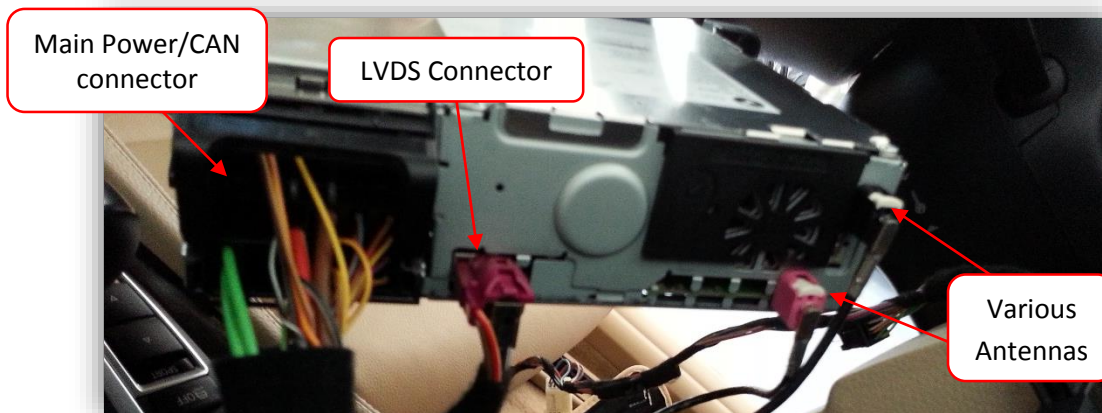

Interface Connections (NON-Plug & Play)*

***For Plug & Play installation, skip this section and refer to 'Plug & Play Interface installation' (next page). Look for these Plug & Play T-Harnesses to determine if your kit is plug & play.**

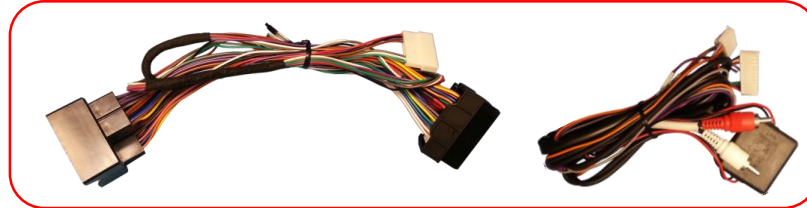

1. The main 44-pin connector at this radio is where the Power (+), Ground (-) and **twisted** CAN wires must be connected. From the BMW12 interface POWER/CAN plug, connect the following*:

Black wire (labeled 'GND'): to thick **BROWN** wire (pin 12)

Red wire (labeled 'ACC'): to the thick **RED/YELLOW** wire (pin 15)*

Green wire (labeled 'CAN L'): to pin **Yellow/Brown** (pin 9)

Green/Red dot wire (labeled 'CAN H'): to **Yellow/Red** (pin 11)

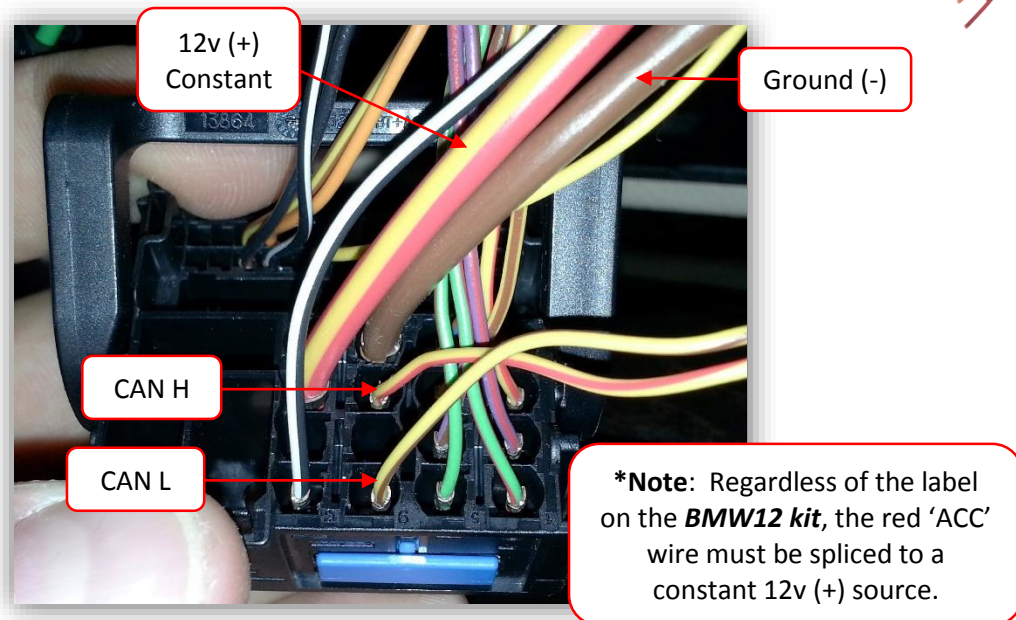

*** Note: the remaining wires/RCA's from this plug are not used for this install.**

2. Proceed to '**Complete Installation**' on page 7.

Plug & Play Interface installation*

****This section is for Plug & Play kits only. For manual wiring instructions, refer to page 5.***

1. Connect the OEM main Power/CAN connector to the female end of the provided **Plug & Play T-Harness**.

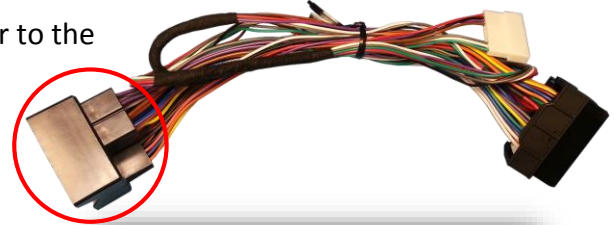

2. Remove the **fiber optic** connector from the OEM plug and re connect it to the male end of the T-Harness.

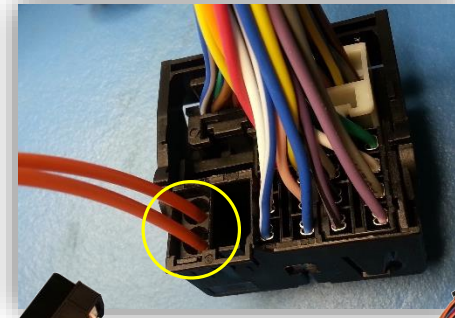

3. Connect the provided **Power/CAN Harness** to the T-Harness via the white, 12-pin connector (located in the center).

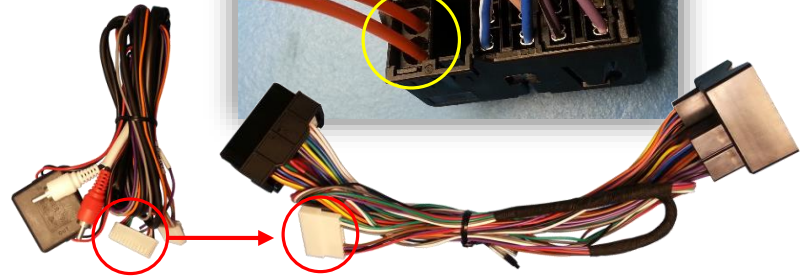

4. Connect the other end of the provided **Power/CAN Harness** to the BMW12 interface at the connector labeled '**POWER**'. **Note: the remaining wires/RCA's from this plug are not used for this install.**
5. Proceed to '**Complete Installation**' on page 7.

Complete Installation

1. Replace the factory LVDS video cable with the LVDS cable provided in the BMW12 kit. To access this cable (behind the factory LCD screen), remove (2x) Torx screws:



2. Remove the factory monitor and disconnect the circular LVDS video cable. Re-connect the free end of this **(factory) LVDS cable to the BMW12 interface at the port labeled 'LCD-IN'**.
3. For single-din radios, use double stick or Velcro to secure the BMW12 interface to the underside of the radio like shown below:

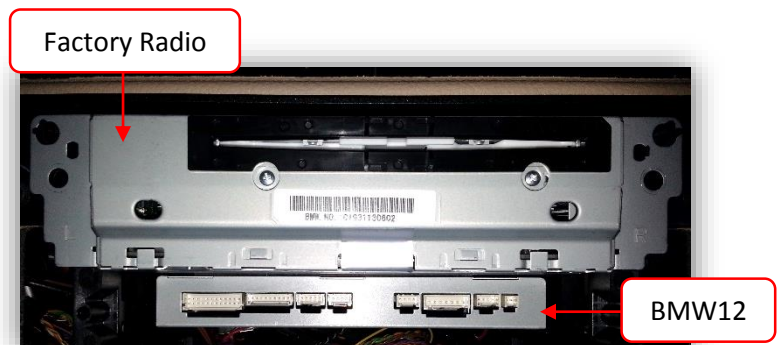

For double-din radio stacks, you'll need to find another mounting location. Dropping the passenger glove box may be necessary.

4. Connect the provided **LVDS video cable** to the factory BMW screen. Run the other end of the LVDS behind the vents and connect it to the BMW12 interface at the port labeled '**LCD-OUT**'.



5. Connect the AV Input cable to the port on the BMW12 interface labeled '**AV IN/OUT**'. If you're only connecting a reverse camera (and no other inputs), the signal input from the camera must connect to the RCA labeled '**REAR-C**'. Refer to the dip-switch settings chart to skip/enable AV sources upon toggle switch presses (optional. Page 2).



- a. If you're installing a NAV-TV **CAM 6** or **Handle Cam** as well, the power connector plugs directly into the BMW12 interface port labeled '**R-CAM**':

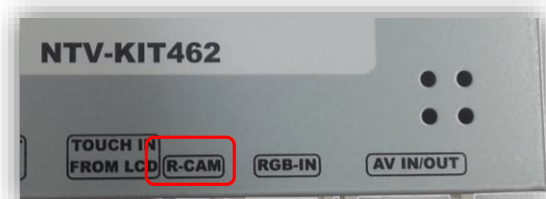

6. **Optional:** Connect the remote eye to the port labeled '**IR**' and leave it in clear view of the driver (often it can be stuck inside a vent). This connection would be necessary if you want to be able to adjust anything from the BMW12 interface's menu.
 - a. **While in any AV mode other than factory** (on the display screen), press the **MENU** button for **Menu 1**, or hold the **left arrow** to enter **MENU 2**.
 - b. To switch between AV modes, press the '**OK**' button.



7. **Optional:** Connect the provided momentary toggle switch to the port on the BMW12 interface labeled '**MODE**'. Pressing this switch with the ignition on will cycle the screen modes as follows: **factory screen > NAVI (RGB) > AV1 > AV2 > AV3 > factory screen**.



8. Connect the male end of the provided **Plug & Play T-Harness** to the radio and connect the remaining OEM plugs to the radio. Start the car and test for proper functionality before replacing dash pieces.

9. **Note:** All other included harnesses not mentioned in this manual are not needed for most installations. If you would like to know more about the full capability of this interface, contact NAV-TV tech support at 561-955-9770. Additional features not mentioned in this manual are not supported by NAV-TV at this time.

If you have a PIP (picture in picture) image when in reverse after installation, press the button that corresponds to your screen size to adjust **while in reverse**:

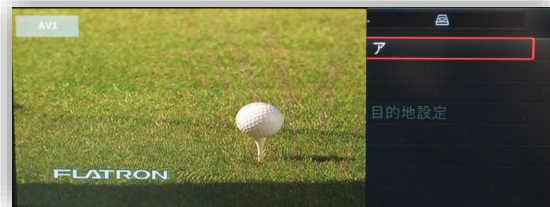

- 6.5" Monitor: Press Voice Command button on steering wheel.**
8.8", 10.2" Monitor: Press and hold the DOWN arrow on the iDRIVE knob.

Menu Adjustments

Before you start:

- Make sure the car's ignition is on and radio is booted/settled
- You must be in 'NAVI' (RGB), 'AV1', 'AV2' or 'AV3' mode (on display screen)
- Use the remote 'OK' button to switch modes, or use the provided input toggle switch
- Hold the **LEFT ARROW** for 3 seconds. The **Menu of FACTORY** will appear on screen.

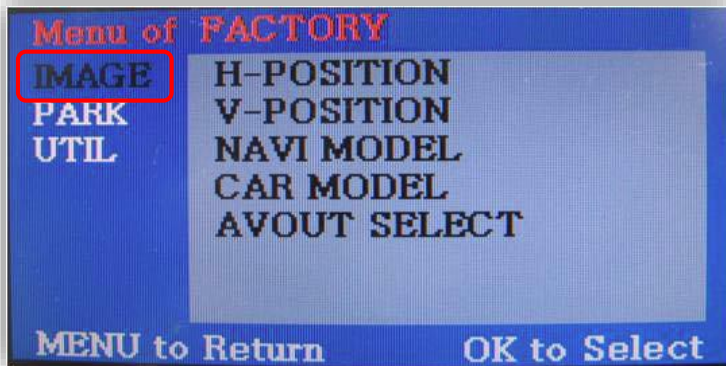
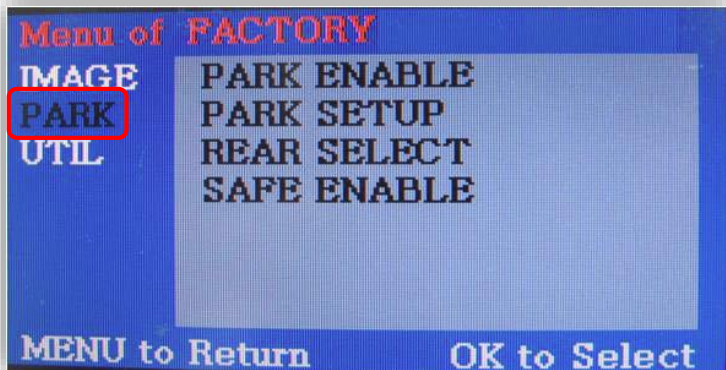

IMAGE MENU

-The only setting that may need necessary adjustment here would be **CAR MODEL** (BMW/AUDI KITS)
Note: on some kits, this option is located under 'UTIL'

-The remaining settings are optional and install dependent.



PARK MENU

PARK ENABLE: Rear-CAM guidelines ON/OFF
PARK SETUP: Rear-CAM guideline positioning
REAR SELECT: Change *rear camera activation* from CAN to LAMP (gray wire) *Note: on some kits, this option is located under 'UTIL'*
SAFE ENABLE: If 'ON', prevents AV sources from showing (unless you ground **Blue 'PARKING' wire**)

1 **Rear-Select CAN to LAMP adjustment** 2

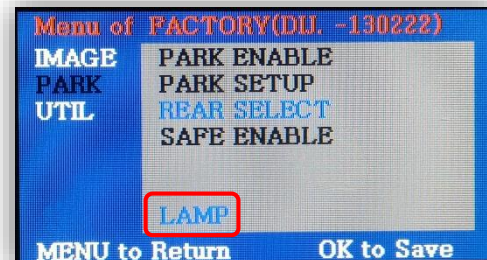
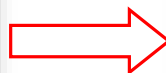
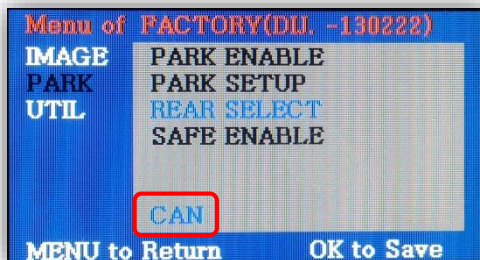

Agreement: End user agrees to use this product in compliance with all State and Federal laws. NAV-TV Corp. would not be held liable for misuse of its product. If you do not agree, please discontinue use immediately and return product to place of purchase. This product is intended for off-road use and passenger entertainment only.

FAQs

Q. I cannot switch A/V sources.

A. Check IR or toggle switch connection. Check the LEDs on the interface, if nothing is lit up with vehicle ignition, check power/ground connections.

Q. All I see on the display is a black screen (no factory image pass-through).

A. Make sure the video cables (IN/OUT) are connected at the proper location (Screen/Radio/NAV DRIVE).

B. Make sure the video cables are seated all the way.

C. Make sure Dip Switches 5 & 6 are set correctly (resolution or screen size).

Q. Displayed image color is not proper (too dim or color seems wrong).

A. Try to select 'INITIAL' in OSD menu.

Q. Rear camera image does NOT appear.

A. Make certain Dip Switch #7 in set **down** for aftermarket camera, or **up** for a factory camera.

B. Try swapping the CAN connection wires. This will not do damage, if it is hooked up wrong it will only not work.

C. Make certain the camera is properly powered. Check voltage **at the camera itself**.

D. Try an alternative video source, don't assume the power/ground is correct unless you've checked it **with a multi-meter!**

E. If this is a CAN-connected module and you've connected the CAN wires, try using the gray wire (*not all interfaces have this wire!*) instead of the CAN connection for reverse activation. You'll also need to change the **Rear Select** option in the **Menu of Factory (MENU 2)** under **UTIL** or **PARK**. Refer to the **Menu Adjustments** section.

Q. Unwanted A/V mode is displayed upon a toggle press (A/V source switching order: OEM->RGB->AV1->AV2->AV3->OEM).

A. Check DIP Switch Setting. Refer to page 2.