

NAV-TV

INTERFACING THE FUTURE

BHM
12/12/16
NTV-DOC277

3950 NW 120th Ave, Coral Springs, FL 33065 TEL 561-955-9770 FAX 561-955-9760

www.nav-tv.com info@nav-tv.com

AUDI-P60

NTV-KIT790



Overview

The *AUDI-P60* Kit interfaces a backup camera input (with active parking lines) & 1 additional composite video into the factory media screen in the 2017 Audi A4, Q7, TT or R8 vehicles with the (MIB2) MMI system. Installation is performed behind the MMI module (inside glove box).

Kit Contents



Infrared Receiver



AUDI-P60 Interface

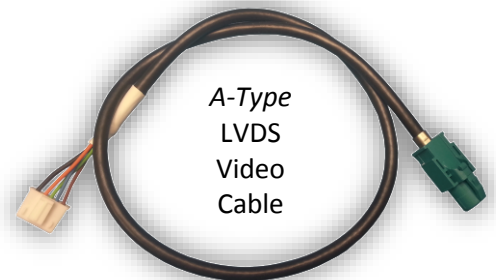

A-Type
LVDS
Video
Cable



OSD Menu Remote

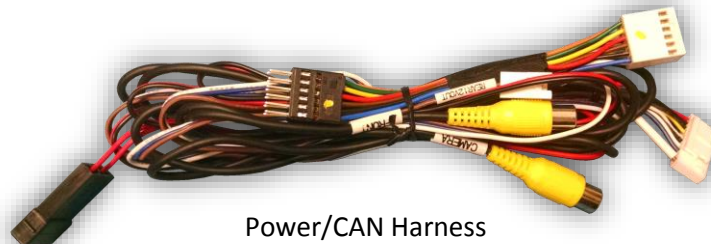

Power/CAN Harness

Agreement: End user agrees to use this product in compliance with all State and Federal laws. NAV-TV Corp. would not be held liable for misuse of its product. If you do not agree, please discontinue use immediately and return product to place of purchase. This product is intended for off-road use and passenger entertainment only.

Interface Connectors

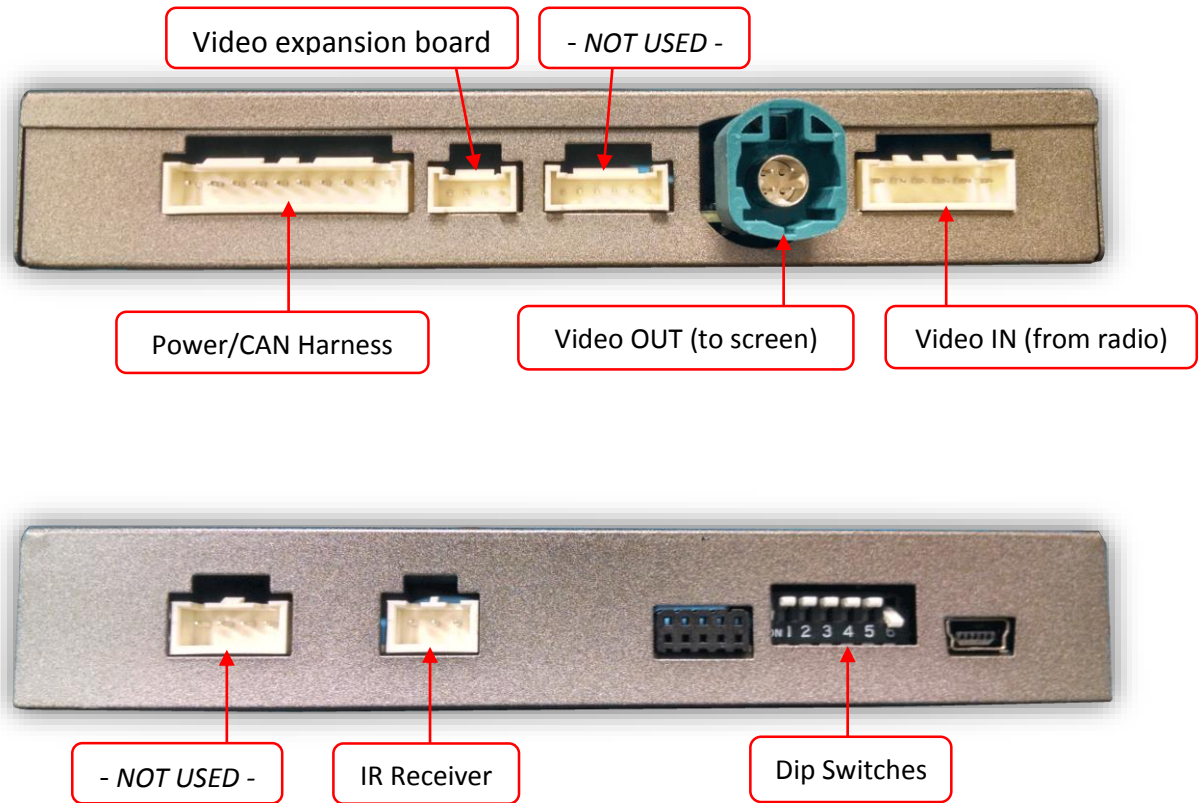

Dip Switch Settings

Dip SW:	1	2	3	4	5	6
UP	N/A	N/A	N/A	OEM RVC	N/A	Keep Down
DOWN	N/A	N/A	N/A	ADDING RVC	N/A	Keep Down

Note: Remove power to the unit prior to making adjustments to the dip switches



Agreement: End user agrees to use this product in compliance with all State and Federal laws. NAV-TV Corp. would not be held liable for misuse of its product. If you do not agree, please discontinue use immediately and return product to place of purchase. This product is intended for off-road use and passenger entertainment only.

AUDI-P60 Installation

1. Remove the MMI module located in glove box – this will require an 8mm socket and possibly a right-angle driver. Disconnect any associated harnesses and set the MMI radio aside.
2. Grab the provided **'Power/CAN Harness'** from the AUDI-P60 kit. Connect the following wires to the car:

Interface wires	Connect to car	Location
Black (Ground)	Chassis Ground	PIN 15 (Radio plug)
Red (ACC 12v)	ACC 12v (+)	Black/White or Black/Blue @ pass fuse box

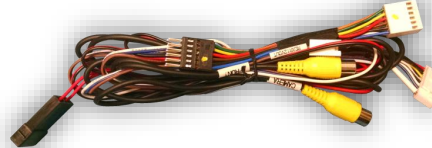
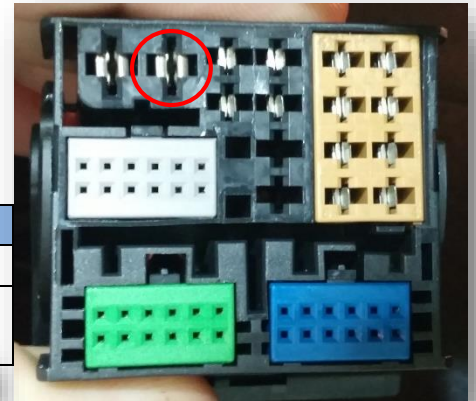

3. Locate the factory **PINK (For AUDI's with NAV, this connector is GRAY)**, 4-pin round connector that was removed from the radio in step 1. Connect this factory plug to the AUDI-P60 interface at the port labeled **'VIDEO OUT'**.*



4. Connect the smaller white plug side of the provided **LVDS Video Cable** to the port on the AUDI-P60 interface labeled **'VIDEO-IN'**.



5. Connect the free end of the provided **LVDS Video Cable** (green) back to the factory radio at the appropriate port.

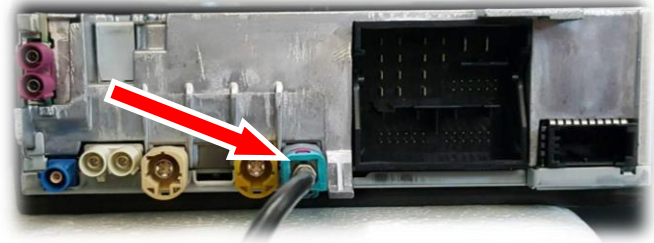

Agreement: End user agrees to use this product in compliance with all State and Federal laws. NAV-TV Corp. would not be held liable for misuse of its product. If you do not agree, please discontinue use immediately and return product to place of purchase. This product is intended for off-road use and passenger entertainment only.

6. Connect the provided 12-pin plug & play portion from the main power harness to the main factory MMI connector as shown below. Pay attention to the orientation, as this is vital to proper operation:

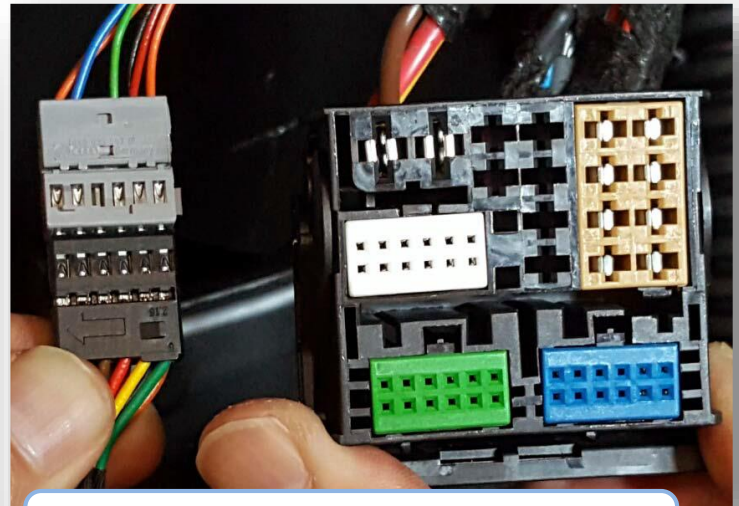

Connect OEM 12-pin to provided 12-pin (black, PIN-side). **NOTE: printed arrow location on provided 12-pin plug vs OEM plug.**

Connect the female 12-pin side of the plug & play portion to the OEM main MMI connector as shown. **Note the paint dot must face towards the thick power wires.**

If the connector does not secure properly, zip tie the harness in place to surrounding wires **leaving slack so that the connector stays in place.** Use a spot of glue on the back side if you're still concerned with this.

Note: sometimes it is easier to connect the main plug back to the MMI module first and then connect this 12-pin in.

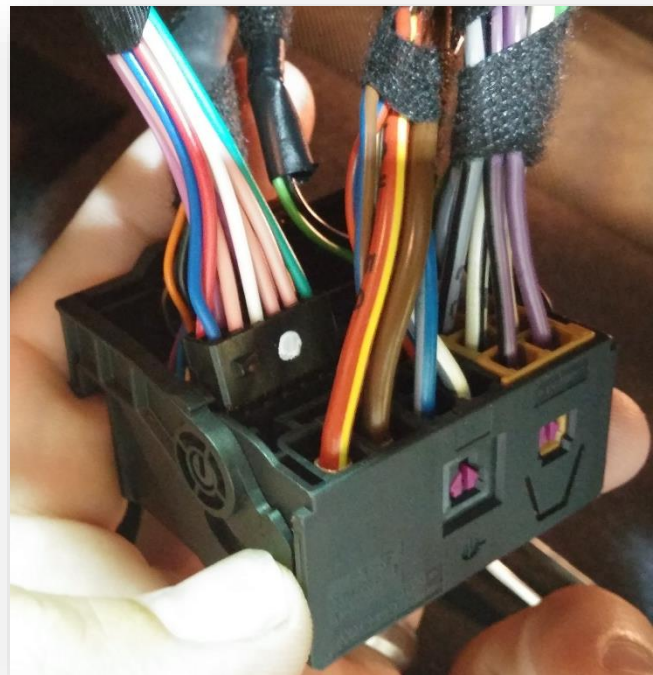

7. Connect ground and power for your camera, you may use the provided **purple** wire (labeled 'REAR12VOUT') for power for convenience. **NOTE: This power source will only supply 12v when the vehicle is in reverse (if forced rear camera is desired at any time, you'll need to use an ACC source for power instead).**

8. Connect the video feed from the camera to the RCA among the main power harness labeled 'CAMERA'.
9. Connect the white plug from the **Power/CAN Harness** to the port on the AUDI-P60 interface labeled '*POWER CAN*'.
10. **Optional:** If adding an additional composite video input (including front camera), connect the video signal to the RCA among the Power/CAN Harness labeled '*CVBSIN*'.
11. **Optional:** Powering (12v) the **green wire** through a toggle switch (not included) among the power harness can be set to show either the '*CAMERA*' RCA or '*CVBSIN*' RCA at will. See OSD Menu settings (page 8 & 9) to adjust '*REVERSE LINE*'.
12. Start the car and test for proper functionality before replacing any dash pieces.

AUDI-P60 Operation

- If a rear camera was installed, placing the vehicle in reverse will show the connected camera's image, with dynamic guidelines for convenience.
- See below for activating additional video inputs:

Steering Wheel



Press & hold **BACK ARROW** (2 seconds) to cycle through installed & active video input options. Order:
OEM-AV1-AV2-AV3-OEM

OR

Press & Release **NAV/MAP** to cycle through installed & active video input options. Order:
OEM-AV1-AV2-AV3-OEM



MMI Control

- Additionally, sending 12v (+) to the **green wire** through a toggle will force the 'CAMERA' or 'CVBSIN' video signal, selectable via the OSD menu. See page 8 & 9.

**Note: These features will only function when active (see OSD Menu)*

AUDI-P60 Install Diagram

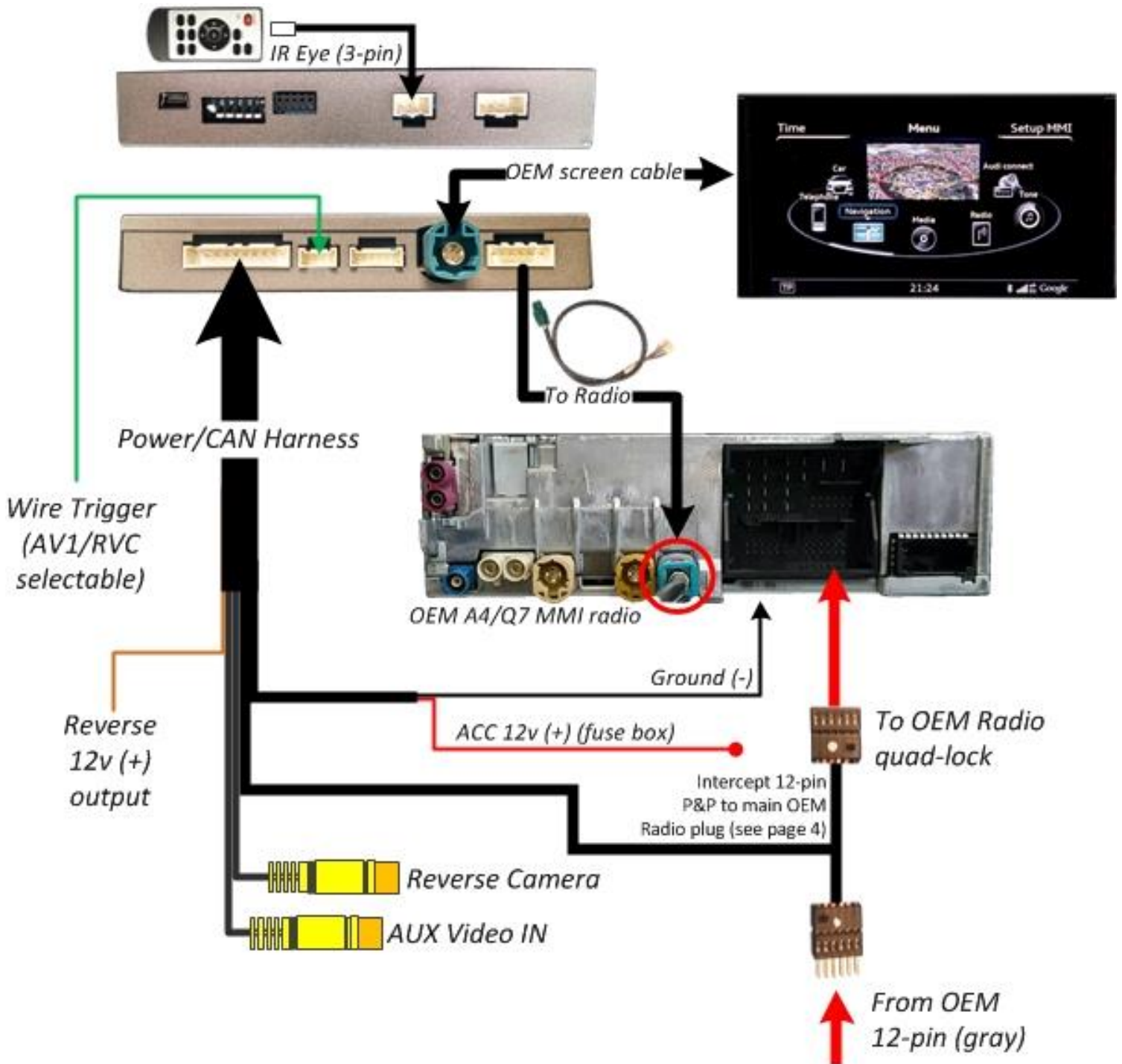

Agreement: End user agrees to use this product in compliance with all State and Federal laws. NAV-TV Corp. would not be held liable for misuse of its product. If you do not agree, please discontinue use immediately and return product to place of purchase. This product is intended for off-road use and passenger entertainment only.

Menu Adjustments

Before you start:

- The IR-Eye must be connected
- Make sure the car's ignition is on and radio is on
- You must be in **Reverse Camera** mode **OR** **AUX Video** mode (see below):
 - **Reverse Camera Mode** adjusts Reverse Camera Settings
 - **AUX Video Mode** adjusts AUX Video Settings
- Press the **OK BUTTON 4 times** (numbers will display per press), then press **POWER**.
- The **OSD Menu** will appear on screen (auto-time out in about 5 seconds if no action occurs).



Return
(AUX VID
menu
control)

RVC Menu

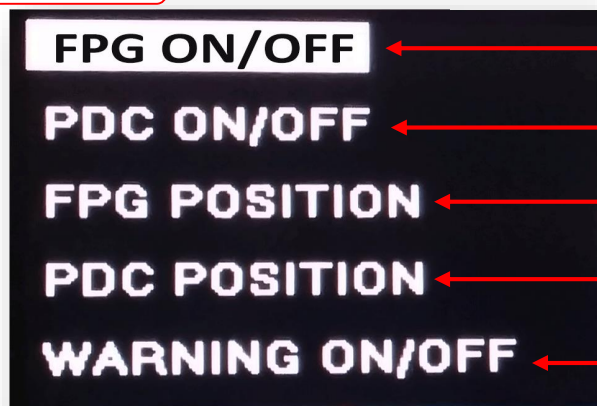

Functional Parking Guidelines ON/OFF

Parking Distance Control
ON/OFF (while in reverse)

Adjust FPG Position

Adjust PDC Position

'Safe to move?' ON/OFF

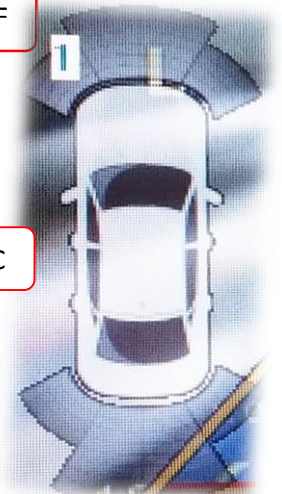

PDC

AUX
VIDEO
Menu

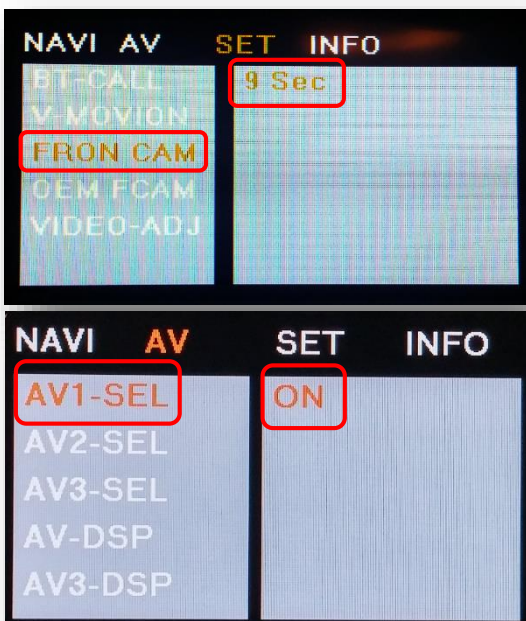

If adding a front camera OR Aux Video source:

1. Disconnect POWER/CAN Harness from interface
2. Place DIP SWITCH 1 in the DOWN position, reconnect power
3. Press the **NAV/MAP** button on the MMI controller to activate **NAV Input**
4. Press **OK** button on remote 4 times, then press **POWER**

SET – FRON CAM must be turned on if adding a *front camera* **and the user wishes for automatic front camera switching**. Options for 5, 7, 9 or 11 seconds are user-selectable for the length of time the front camera input stays active once the vehicle is placed out of reverse.

If the user wants only an AUX video input **without front camera**, set **AV1-SEL** to **ON**, leave **FRON CAM** off.

Once finished with settings, place DIP SWITCH 1 back into the **UP position** and reset power to interface.

Agreement: End user agrees to use this product in compliance with all State and Federal laws. NAV-TV Corp. would not be held liable for misuse of its product. If you do not agree, please discontinue use immediately and return product to place of purchase. This product is intended for off-road use and passenger entertainment only.

AUDI-P60H OSD Menu Options *continued*

BT-CALL

- **BT-CALL:** How a (OEM setup) Bluetooth phone call is handled while in AV/HDMI mode:
 - **ON** - When in AV mode, the unit will transition to the OEM screen when a Bluetooth phone call is active, then return when call is ended.
 - **OFF** - There is no screen transition when a BT call is active. The screen will remain in whatever mode it is currently on.

FRON CAM

- **V-MOVION:** N/A
- **FRON CAM:** Front camera timer (AV1) = without expansion board; (AV3) with expansion board
 - **5s, 7s, 9s, 11s:** Choose one (timer, in seconds), for the amount of time the *front camera (AV1)* shows after the vehicle is transitioned out of reverse gear
 - **OFF:** No timer activation

VIDEO-ADJ

- **OEM FCAM:** N/A
- **VIDEO ADJ:** Adjust video settings for AV1/AV2, etc
- **AIR-CON:** Used on vehicles that display the HVAC/volume information on the screen whenever an adjustment is made.
 - **ON:** When in AV mode, the screen will transition to the OEM screen to display the HVAC/volume adjustment, then auto transition back to AV mode.
 - **OFF:** When in AV mode, the screen will remain while HVAC/volume adjustments are made.

AIR PIP ON

- **REAR MODE:** Used to determine operation when the vehicle is placed into reverse.

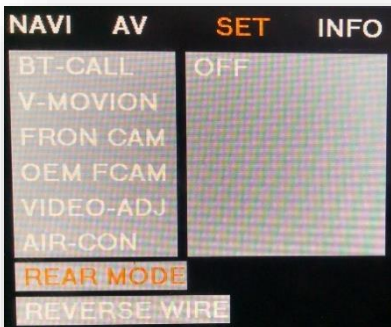

- **ON:** RVC dip switch (#4) dependent (follows DS #4).
- **OFF:** The unit will ignore the reverse gear. (No screen transition in AV or OEM)
 - **DIP 4 ON: Aftermarket camera input:** In AV/HDMI or OEM, the screen will transition to the RVC input when reverse is detected. Will display any extra overlay info, PDC, active guidelines.
 - **DIP 4 OFF: OEM equipped camera:** In AV/HDMI the unit will transition into the OEM screen when reverse is detected.

- **REVERSE WIRE:** Providing 12v (+) to the **green wire** acts as an external activation for the selected input (connect through toggle switch, SVS-6, etc).
 - **REAR MODE:** Follows the REAR MODE operation (with guideline overlay and any additional options)
 - **REAR:** Displays the RVC input video in its raw form (no extra overlays)
 - **AV1:** Displays AV1 input