

NAV-TV

INTERFACING THE FUTURE

3950 NW 120th Ave, Coral Springs, FL 33065 TEL 561-955-9770 FAX 561-955-9760

www.nav-tv.com info@nav-tv.com

BMW12N-DYNAMIC KIT

NTV-KIT717



Overview

The BMW12-N kit interfaces 2 video inputs (including a backup camera) to the factory media screen in select 2012+ BMWs **with the 6-pin video connector (at the screen)**. This interface generates steering-based guidelines while in reverse for added convenience. *NOTE: 2017 year 'EVO' touch-screen monitors or 'CID' labeled monitors are NOT compatible with this interface.*

Kit Contents



HD-LINK Optional KIT800



BMW12-N Interface
NTV-INT244

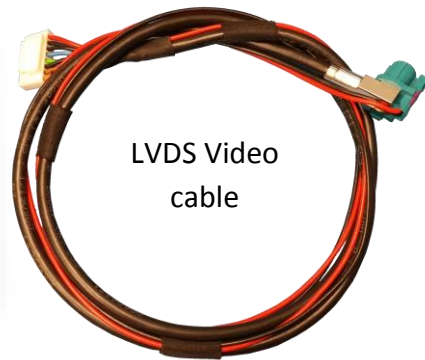

LVDS Video cable

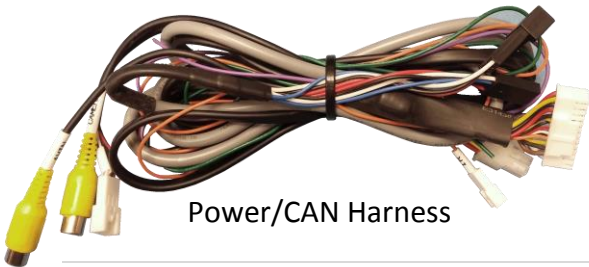

Power/CAN Harness



Remote (menu control)



IR Eye Harness

Agreement: End user agrees to use this product in compliance with all State and Federal laws. NAV-TV Corp. would not be held liable for misuse of its product. If you do not agree, please discontinue use immediately and return product to place of purchase. This product is intended for off-road use and passenger entertainment only.

Interface Connectors

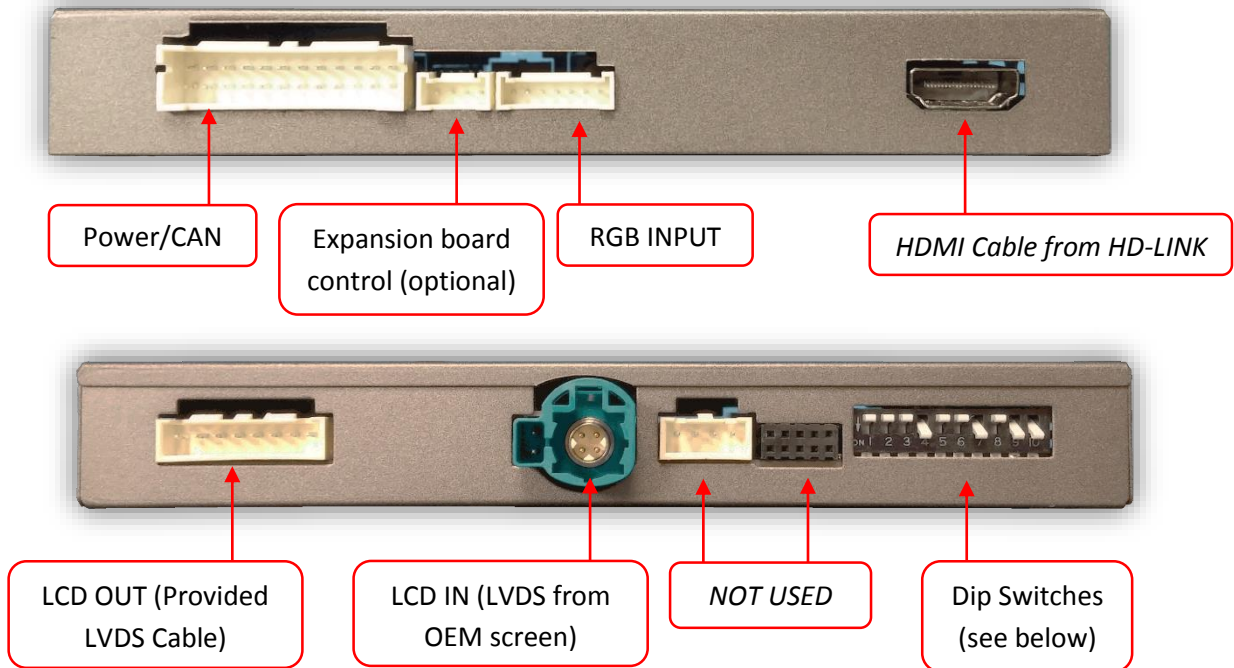

Dip Switch settings*

Dip SW:	1	2	3	4	5	6	7	8	9	10
UP	KEEP UP	SKIPS V1	SKIPS V2	RVC OFF	CAN SETTING	CAN SETTING	CAN SETTING	HIGH RES	VEH SETTING	KEEP DOWN
DOWN	KEEP UP	ENABLES V1	ENABLES V2	RVC ON	CAN SETTING	CAN SETTING	CAN SETTING	LOW RES	VEH SETTING	KEEP DOWN

Known Dip Switch Configuration



2013: 1 & 3 series
8.8" screen



2014: 1 series
6.5" screen



2014+: 3, 5, 7 series
10.2" screen



2014: MINI
8.8" screen



2015: MINI
6.5" screen



2015: X-series
8.8", 10.2" screen



***Note: after adjusting Dip Switches, you must disconnect and reconnect power to the interface or the change will not be implemented.**



2016: 3-series
6.5" screen



'13-'15: X-3 & 3-series
6.5" screen

BMW12-N Interface Installation (5 Series example)

1. The BMW12-N intercepts **two OEM harnesses in two locations**: the iDrive knob and the screen. You must gain access to both places for proper installation.
 - a. Access the rear of the screen by removing the dashboard panel (clips only) and then removing (2x) Torx T20 screws securing the screen to the sub-dash.



2. To access the iDrive harness, remove the panel surrounding it (may have Torx screw securing to sub dash)

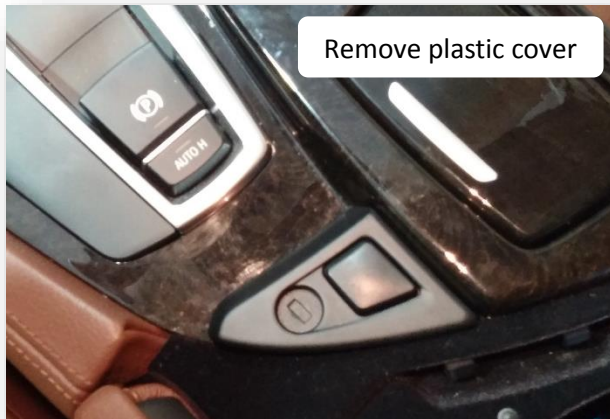

3. Lift up the lower dash panel and disconnect 4-PIN plug powering the iDrive knob.

4. Connect provided 4-PIN T-Harness in between iDrive knob and OEM harness as shown.



Agreement: End user agrees to use this product in compliance with all State and Federal laws. NAV-TV Corp. would not be held liable for misuse of its product. If you do not agree, please discontinue use immediately and return product to place of purchase. This product is intended for off-road use and passenger entertainment only.

4. Replace the lower dash panel (with iDrive knob) back to sub-dash.

5. Disconnect the OEM screen LVDS video cable and connect it to the port on the BMW12-N labeled 'LCD-IN'.

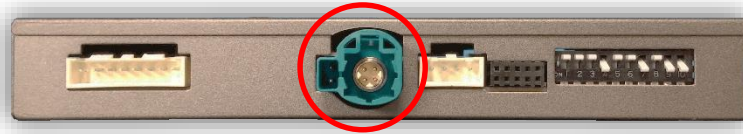

6. Connect the provided LVDS Video Cable to the port on the BMW12-N labeled 'LCD-OUT' and the other end back to the screen.



7. Install and run the reverse camera video source power and signal to the BMW12-N interface location and connect to the RCA labeled 'CAMERA'. Power your camera with an ACC source or use the **violet wire** for reverse 12v (+) only. *NOTE: this wire outputs 500 mA MAX – do not use to supply power to more than 1 camera. Use this wire to trigger a relay if you're concerned with current supply.*

8. **Optional:** If installing a secondary camera or AUX video source, connect signal RCA to the RCA on the BMW12-N interface labeled 'AVIN'.

7. After DIP switch settings have been set (see page 2), connect the 24-PIN power connector to the BMW12-N interface labeled 'POWER CAN'. Proceed to **Menu Options** section if necessary (front camera settings, etc) or to **BMW12-N Operation**.

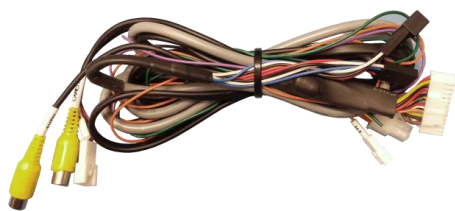

UPDATE: 2017 year 'EVO' touch-screen monitors or 'CID'-labeled monitors are *NOT* compatible with this interface.



Menu Adjustments

Before you start:

- The IR-Eye must be connected
- Make sure the car's ignition is on and radio is on
- You must be in **Reverse Camera** mode **OR AUX Video** mode (see below):
 - **Reverse Camera Mode** adjusts Reverse Camera Settings
 - **AUX Video Mode** adjusts AUX Video Settings
- Press the **OK BUTTON 4 times** (numbers will display per press), then press **POWER**.
- The **OSD Menu** will appear on screen (auto-time out in about 5 seconds if no action occurs).



Return
(AUX VID menu control)

RVC Menu

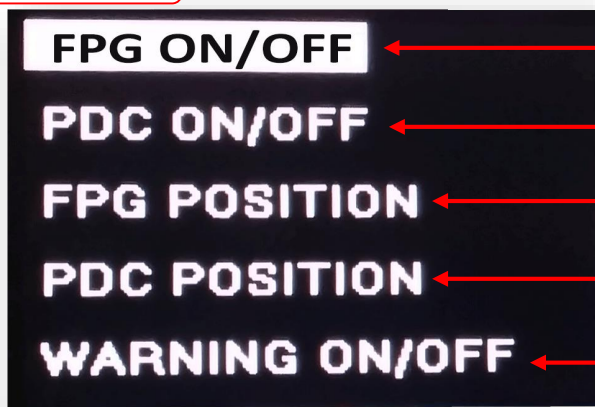

Functional Parking Guidelines ON/OFF

Parking Distance Control ON/OFF (while in reverse)

Adjust FPG Position

Adjust PDC Position

'Safe to move?' ON/OFF

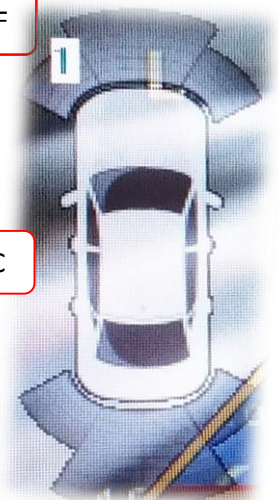

PDC

AUX VIDEO Menu

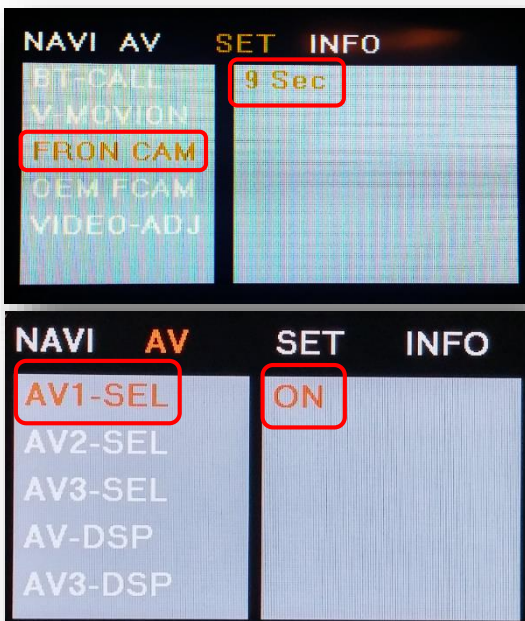

If adding a front camera OR Aux Video source:

1. Disconnect POWER/CAN Harness from interface
2. Place DIP SWITCH 1 in the DOWN position, reconnect power
3. Press and hold the iDRIVE knob 'MENU' to activate the AUX screen
4. Press **OK** button on remote 4 times, then press **POWER**

SET – FRON CAM must be turned on if adding a front camera **and the user wishes for automatic front camera switching**. Options for 5, 7, 9 or 11 seconds are user-selectable for the length of time the front camera input stays active once the vehicle is placed out of reverse.

If the user wants only an AUX video input **without front camera**, set **AV1-SEL** to **ON**

Once finished with settings, place DIP SWITCH 1 back into the **UP position** and reset power to interface.

Agreement: End user agrees to use this product in compliance with all State and Federal laws. NAV-TV Corp. would not be held liable for misuse of its product. If you do not agree, please discontinue use immediately and return product to place of purchase. This product is intended for off-road use and passenger entertainment only.

Adding HD-LINK Adapter (HDMI Input)

Follow the instructions below when adding the HDMI adapter (HD-LINK) to enable HDMI input to the OEM screen:



1. Put dip switch #1 in the **DOWN** position.
2. Activate the 'NAV INPUT' by **holding** the 'MENU' button on the iDRIVE knob.
3. Once 'NAV INPUT' shows on the screen, on the remote press the **OK BUTTON 4 times**, then press **POWER**.
4. Navigate to the 'NAVI' section.
 - a. Select 'HDMI-SEL'
 - b. Choose 'HD95E'
 - c. Press **MODE** on the remote to return and exit the OSD menu (or let it time out).
5. Replace dip switch #1 to the **UP** position.
6. Connect the **black wire** to ground (-) and the **red wire** to ACC power (+) from the main power connector on the **HD-LINK** adapter. The RCA's on this plug provide audio from the HDMI source.

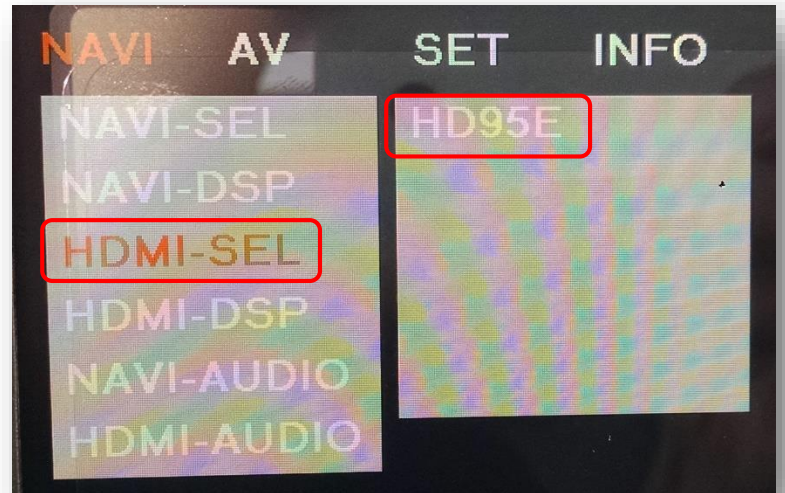

BMW12-N Installation Diagram

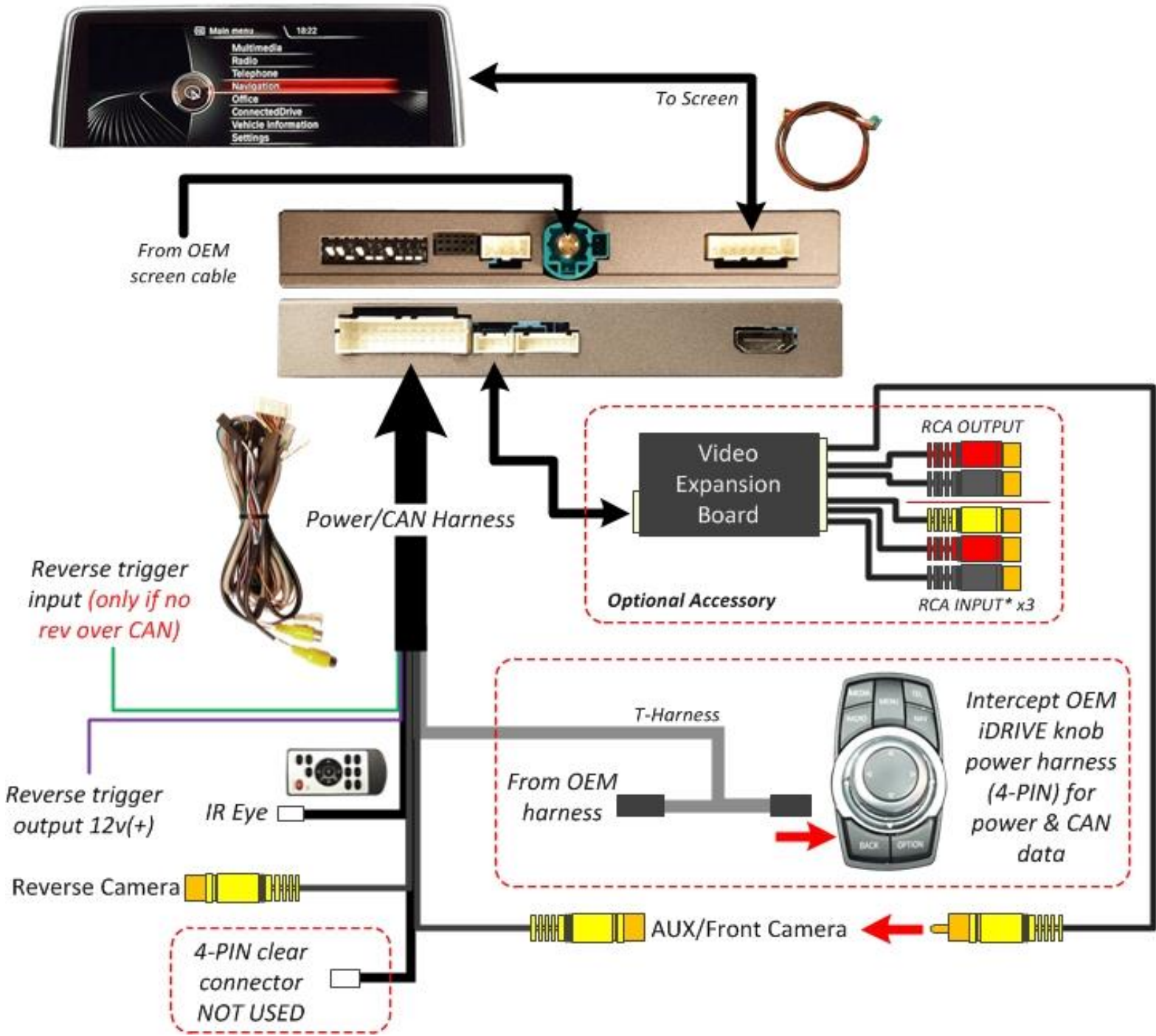

Agreement: End user agrees to use this product in compliance with all State and Federal laws. NAV-TV Corp. would not be held liable for misuse of its product. If you do not agree, please discontinue use immediately and return product to place of purchase. This product is intended for off-road use and passenger entertainment only.

BMW12-N Operation

- Once all connections are made and dip switches are set properly, placing the vehicle in reverse will display the connected camera with dynamic guidelines for convenience.
- Additionally, see below for AUX/Front camera activation using factory buttons.



Hold (3 sec): Activate AUX/Front Camera video input

Hold (3 sec): Change AUX/Front Camera view (60/40 split, etc)

Hold (3 sec) WHEN IN REVERSE: 2013-2015 3,5,7,X series: Change Rear Camera view (60/40 split, etc)

Hold (3 sec) WHEN IN REVERSE: 2013-2015 1 series/MINI: Change Rear Camera view (60/40 split, etc)

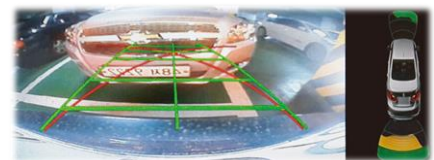

Agreement: End user agrees to use this product in compliance with all State and Federal laws. NAV-TV Corp. would not be held liable for misuse of its product. If you do not agree, please discontinue use immediately and return product to place of purchase. This product is intended for off-road use and passenger entertainment only.