

NAV-TV

INTERFACING THE FUTURE

BHM
06/27/17
NTV-DOC262

3950 NW 120th Ave, Coral Springs, FL 33065 TEL 561-955-9770 FAX 561-955-9760

www.nav-tv.com info@nav-tv.com

PCM4-CAM

NTV-KIT750



Overview

The PCM4-CAM Kit interfaces a backup camera input (with active parking lines) and 1 additional video input (front cam, etc) to the factory media screen in the 2017 Porsche vehicles equipped with PCM4.0, 2015+ Audi A3 and 2015+ Golf VII. Installation is performed behind the radio (disc player).

Kit Content

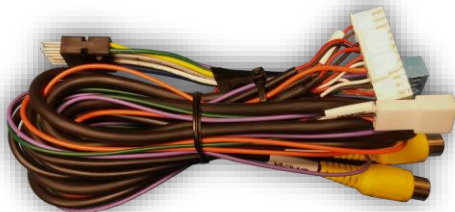

Power/CAN Harness



PCM4-CAM Interface

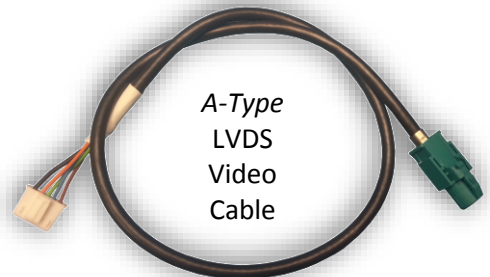

A-Type
LVDS
Video
Cable



Wire trigger cable (optional)



Infrared Receiver



OSD Menu Remote

Agreement: End user agrees to use this product in compliance with all State and Federal laws. NAV-TV Corp. would not be held liable for misuse of its product. If you do not agree, please discontinue use immediately and return product to place of purchase. This product is intended for off-road use and passenger entertainment only.

Interface Connectors

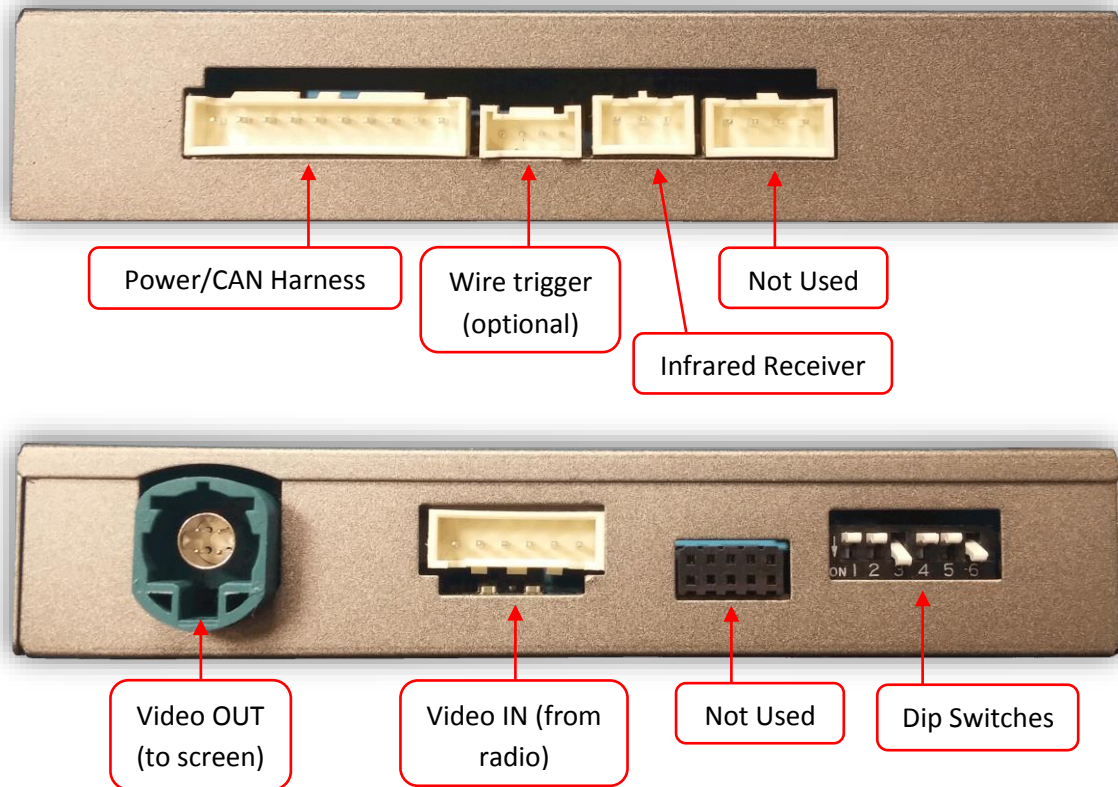

Dip Switch Settings

Dip SW:	1	2	3	4	5	6
UP	ALL OTHER VEH	AV1 OFF	AUDI/GOLF	CAN TYPE	HIGH RES	KEEP DOWN
DOWN	'17+ AUDI 7"	AV1 ON	PORSCHE	CAN TYPE	LOW RES	KEEP DOWN



Note: Remove power to the unit prior to making adjustments to the dip switches.

Installation (Porsche)

Installation connections remain the same for Audi and Golf. Be sure to set dip switches appropriately.

1. Remove the factory radio. Disconnect any associated harnesses and set the radio aside.
2. Grab the provided **Power/CAN Harness** from the PCM4-CAM kit. Connect the following wires to the *car radio's main power plug**:

Interface wires	Connect to car	Radio Plug
Black (Ground)	Chassis Ground	PIN 15 (Brown)
Red (Constant 12v)	Constant 12v (+)	PIN 16 (Red/Yellow)
Green (Rev 12v in)*	Reverse Lamp (+)	---

*Note: this Green wire is ONLY used if CAN connection does not switch display to reverse image while in reverse properly.

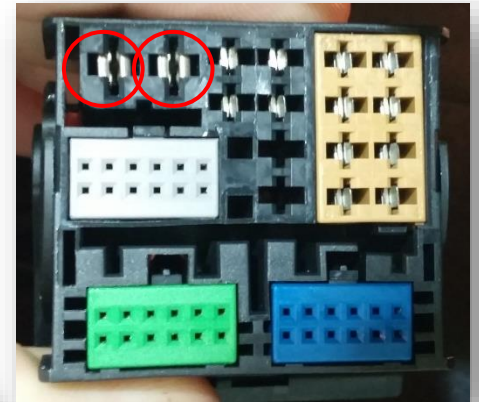
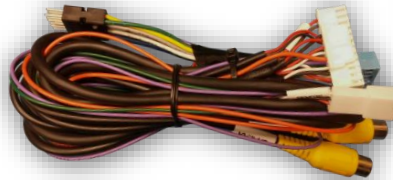

3. Locate the factory **Green (at the radio, NOT the screen)**, 4-pin round LVDS video connector that was removed from the radio in step 1. Connect this factory plug to the PCM4-CAM interface at the port labeled **'VIDEO OUT'**.*

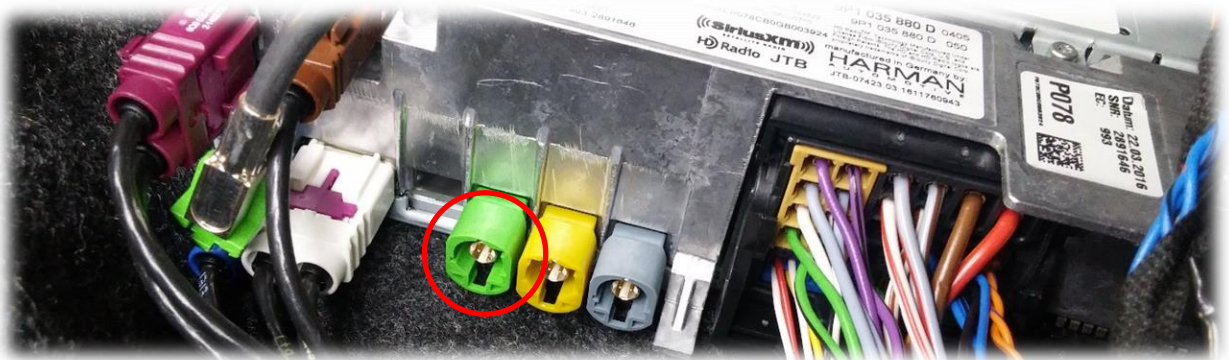

4. Connect the smaller white plug side of the provided **LVDS Video Cable** to the port on the PCM4-CAM interface labeled **VIDEO-IN**.

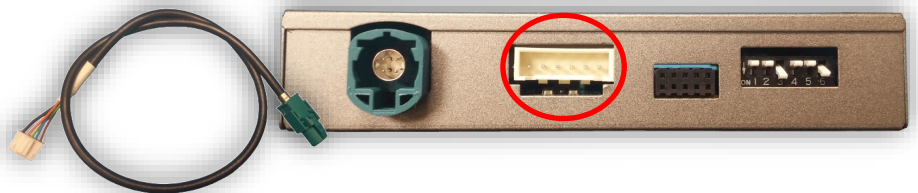

Agreement: End user agrees to use this product in compliance with all State and Federal laws. NAV-TV Corp. would not be held liable for misuse of its product. If you do not agree, please discontinue use immediately and return product to place of purchase. This product is intended for off-road use and passenger entertainment only.

5. Connect the free end of the provided **LVDS Video Cable** (green) back to the factory radio at the appropriate port (if keyways must be cut, do so).
6. Connect the provided 12-pin plug & play portion from the main power harness to the main factory quad-lock connector as shown below. Pay attention to the orientation, as this is vital to proper operation:



Connect OEM 12-pin to provided 12-pin (black, PIN-side). **NOTE: blue and green wire corner locations on provided plug vs OEM.**

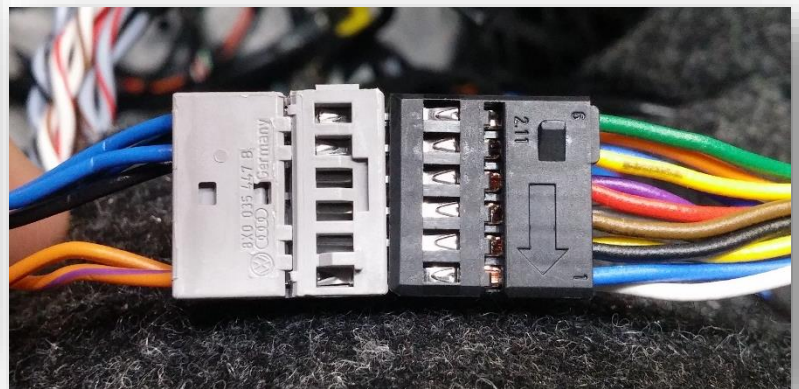

Connect the female 12-pin side of the plug & play portion to the OEM main quad-lock connector as shown. **Note the paint dot must face towards the power wires.**

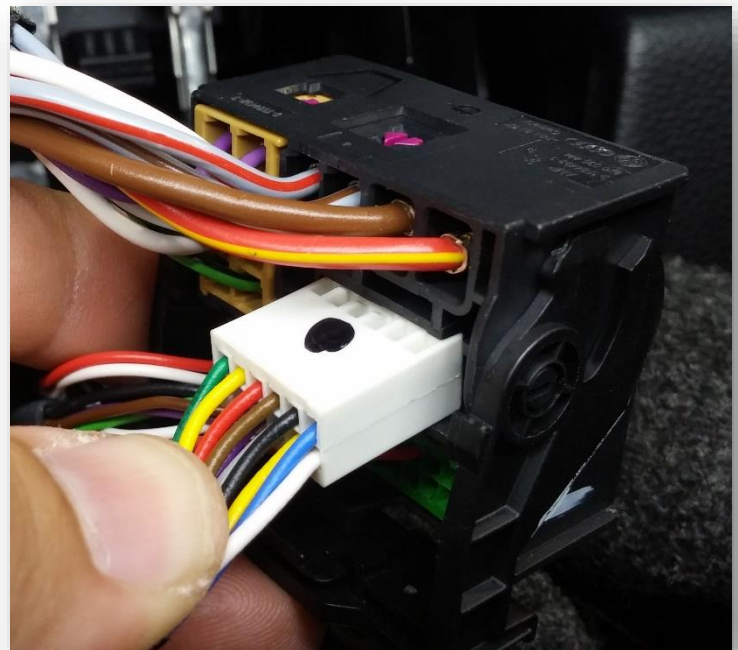

7. Connect ground and power for your camera (use an ACC source for power) and run to the front of the vehicle.
8. Connect the video feed from the camera to the RCA among the main power harness labeled 'CAMERA'.
9. Connect the white plug from the **Power/CAN Harness** to the port on the PCM4-CAM interface labeled 'POWER CAN'.
10. **Optional:** If adding an additional video input (including front camera), connect the video signal to the RCA among the Power/CAN Harness labeled 'FRONT'.
11. Start the car and test for proper functionality before replacing any dash pieces.
12. ***If the screen does not transition to reverse image when in reverse, connect the Green wire labeled 'REVERSE' to an OEM reverse lamp 12v (+) wire. This is sometimes the case with manual transmission-equipped vehicles.***

PCM4-CAM Install Diagram

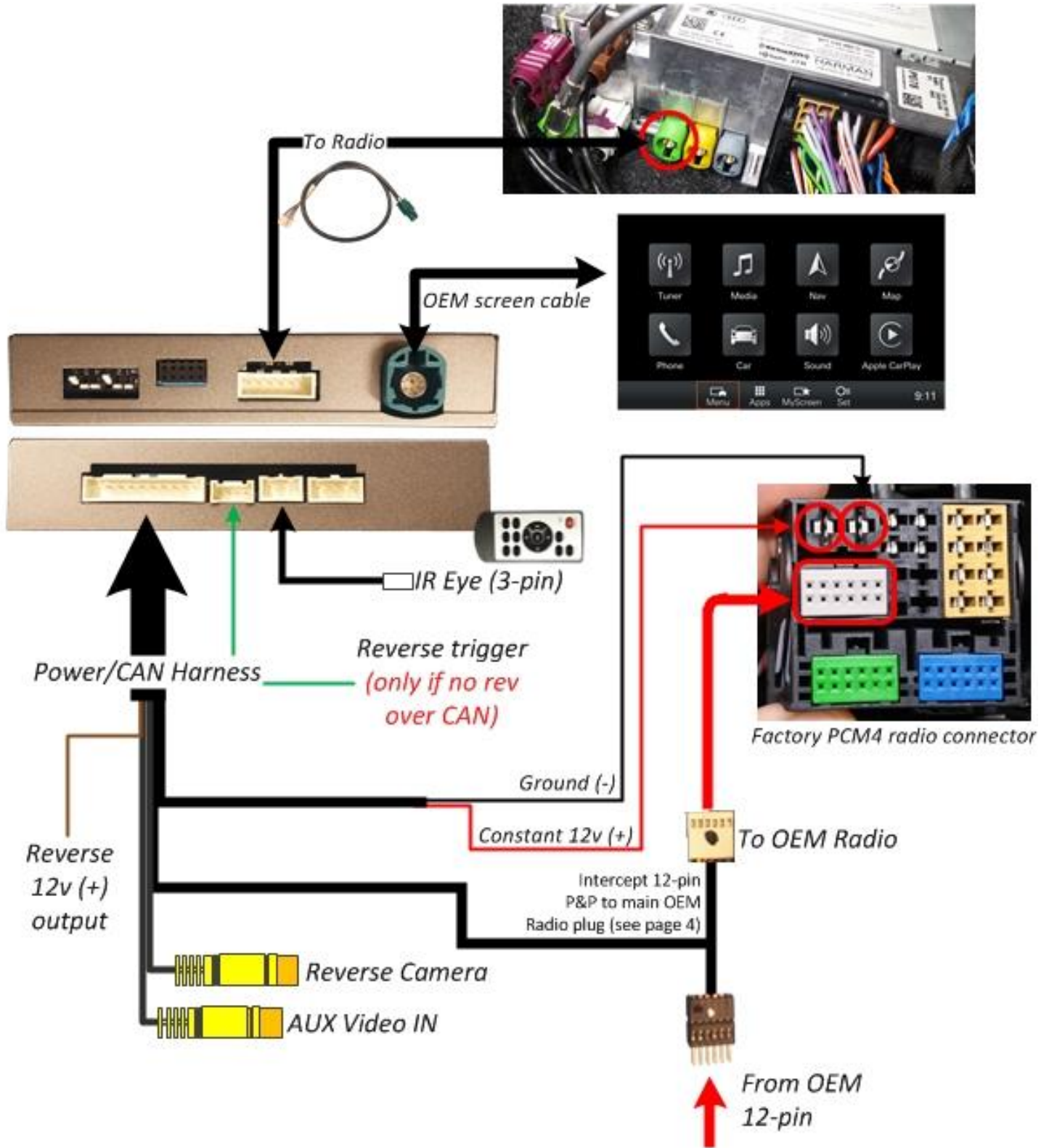

Agreement: End user agrees to use this product in compliance with all State and Federal laws. NAV-TV Corp. would not be held liable for misuse of its product. If you do not agree, please discontinue use immediately and return product to place of purchase. This product is intended for off-road use and passenger entertainment only.

Menu Adjustments (dynamic guidelines, AUX video, front camera etc)

Before you start:

- The IR-Eye must be connected, (connects to main harness)
- Make sure the car's ignition is on and radio is on
- You must be in **Reverse Camera** mode.
- Press the **OK BUTTON 4 times** (numbers will display per press), then press **POWER**.
- The **OSD Menu** will appear on screen (auto-time out in about 5 seconds if no action occurs).

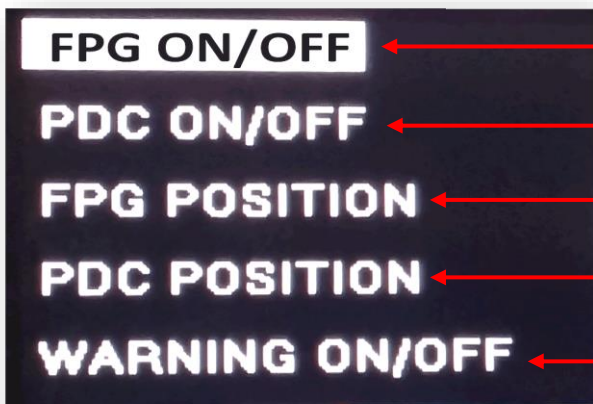
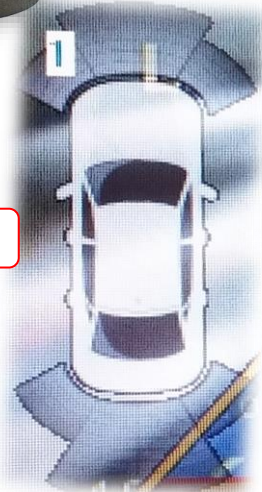
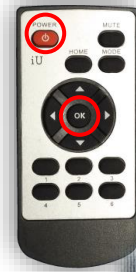

Functional Parking Guidelines ON/OFF

Parking Distance Control ON/OFF (while in reverse)

Adjust FPG Position

Adjust PDC Position

'Safe to move?' ON/OFF

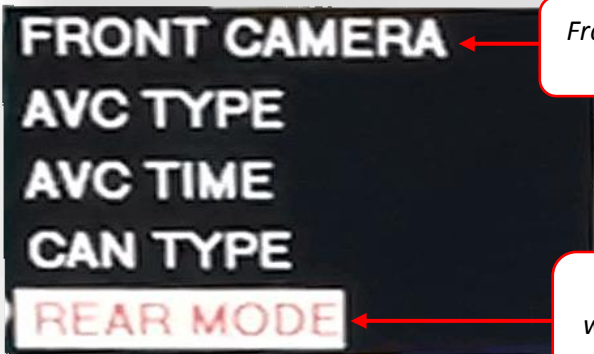

Front camera timer (after reverse)

CAN control while in reverse (see below)



Use if vehicle has OEM reverse camera



Use if adding aftermarket rev camera (default)



Use if adding **only** AUX input/front cam

In the event that **REAR MODE** has been changed to **OEM** or **OFF** and you can no longer access the OSD menu:

1. Car must be on, radio resting on **Reverse Gear Screen**
2. Press **OK** on the remote **4 times** then press **MODE (not MENU)**. Note: there will be no indication of OK presses this time.
3. Reverse (aftermarket) guidelines should appear. Now press **OK** on the remote **4 times** then press **MENU (not MODE)** to enter the OSD menu as typical.

- **SET – FRON CAM** must be turned on if adding a **front camera and the user wishes for automatic front camera switching**. Options for 5, 7, 9 or 11 seconds are user selectable for the length of time the front camera input stays active once the vehicle is placed out of reverse.

PCM4-CAM Operation (Porsche)

- Once all connections are made, placing the vehicle in reverse will display the connected camera image on the PCM4 screen.
- If an AUX video source is connected to the secondary RCA, press and hold the **phone hang up button** on the steering wheel for 2 seconds to display this video source at any time.
- Alternatively (or if vehicle is not equipped with steering wheel controls), pressing the **MAP** button once will cycle between the navigation map and provided AUX video, if active (OSD menu).



NOTE: Dip switch #2 must be DOWN for AUX video to display.

PCM4-CAM Operation (AUDI A3)

- Once all connections are made, placing the vehicle in reverse will display the connected camera image on the media screen.
- If an AUX video source is connected to the secondary RCA, press and hold the **iNAV button** on the steering wheel for 2 seconds to display this video source at any time.



NOTE: Dip switch #2 must be DOWN for AUX video to display.

PCM4-CAM Operation (2017+ AUDI A4, Q7, '18 Q5)

- Once all connections are made, placing the vehicle in reverse will display the connected camera image on the media screen.
- If an AUX video source is connected to the secondary RCA, press and hold the **BACK (arrow) button** on the steering wheel for 2 seconds to display this video source at any time.



*NOTE: Dip switch #2 must be DOWN
for AUX video to display.*