

NAV-TV

INTERFACING THE FUTURE

3950 NW 120th Ave, Coral Springs, FL 33065 TEL 561-955-9770 FAX 561-955-9760

www.nav-tv.com info@nav-tv.com

BMW12N-H

NTV-KIT791

BHM
02/06/17
NTV-DOC278



Overview

The BMW12N-H kit interfaces 2 composite video inputs & HDMI input to the factory media screen in select 2012+ BMWs **with the 6-pin video connector (at the screen)**. This interface generates steering-based guidelines while in reverse for added convenience.

*NOTE: 2017 year 'EVO' touch-screen monitors are **NOT compatible** with this interface.*

Kit Contents

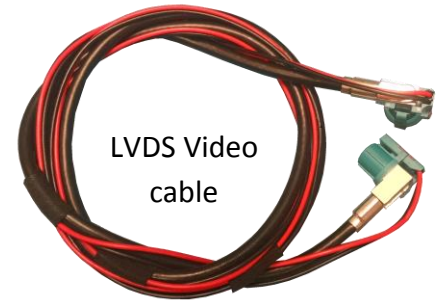

BMW12N-H Interface

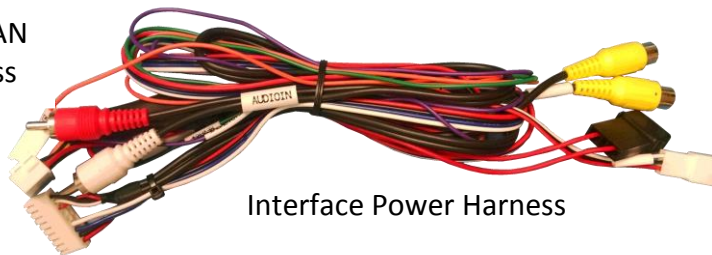
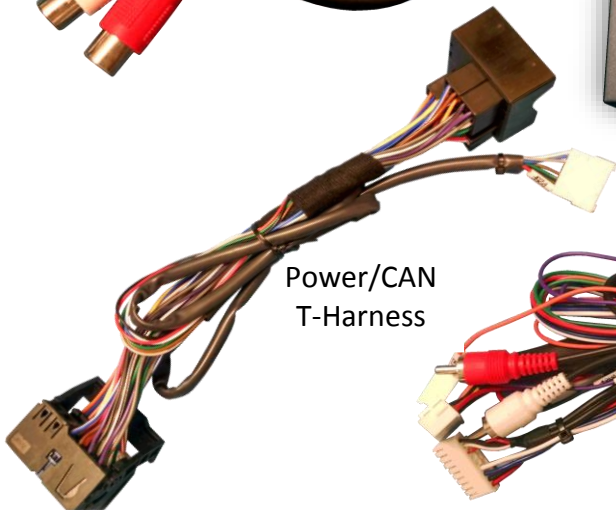
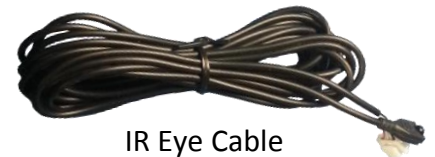

Remote (menu control)

Agreement: End user agrees to use this product in compliance with all State and Federal laws. NAV-TV Corp. would not be held liable for misuse of its product. If you do not agree, please discontinue use immediately and return product to place of purchase. This product is intended for off-road use and passenger entertainment only.

Interface Connectors

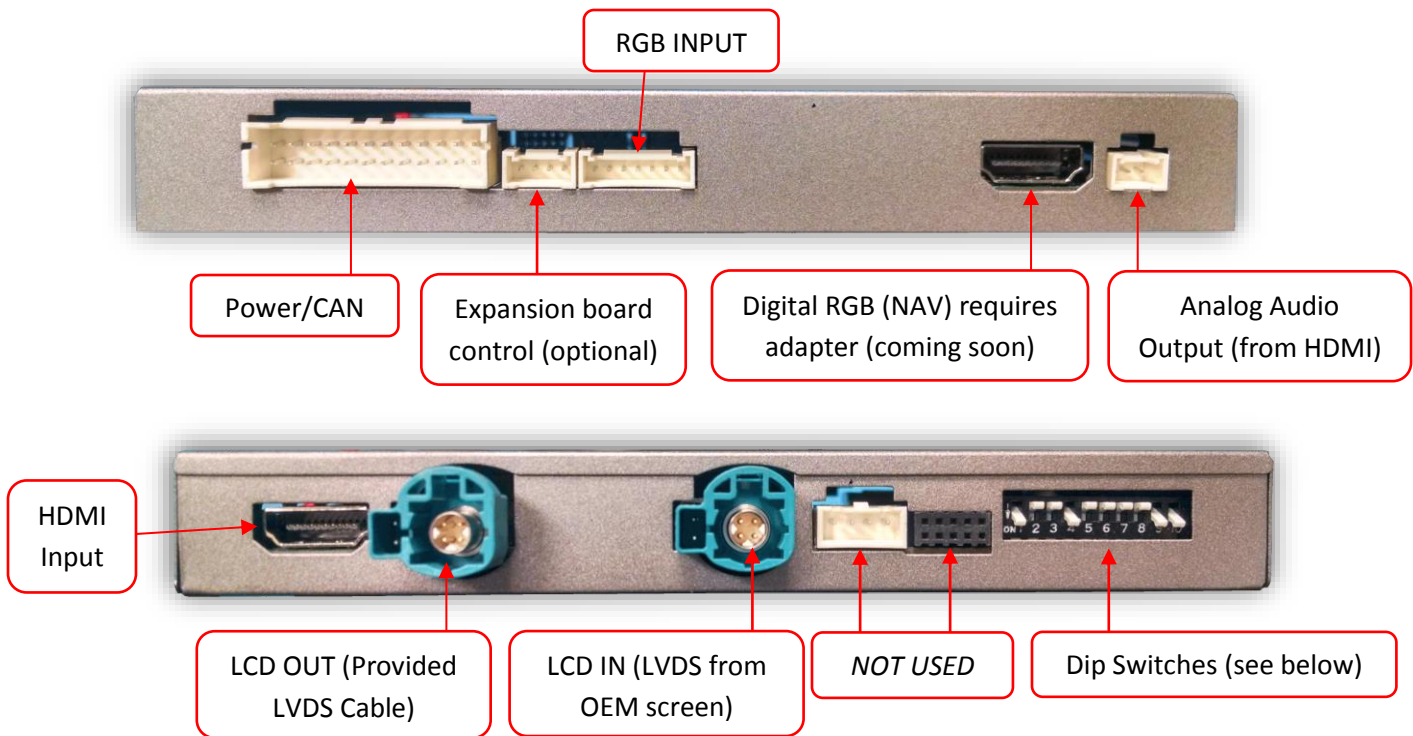

Dip Switch settings*

Dip SW:	1	2	3	4	5	6	7	8	9	10
UP	KEEP UP	SKIPS V1	SKIPS V2	RVC OFF	CAN SETTING	CAN SETTING	CAN SETTING	HIGH RES	VEH SETTING	KEEP DOWN
DOWN	KEEP UP	ENABLES V1	ENABLES V2	RVC ON	CAN SETTING	CAN SETTING	CAN SETTING	LOW RES	VEH SETTING	KEEP DOWN

Known Dip Switch Configuration



2013: 1 & 3 series
8.8" screen

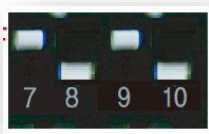

2014: 1 series
6.5" screen



2014+: 3, 5, 7 series
10.2" screen



2014: MINI
8.8" screen



2015: MINI
6.5" screen



2015: X-series
8.8", 10.2" screen



***Note: after adjusting Dip Switches, you must disconnect and reconnect power to the interface or the change will not be implemented.**

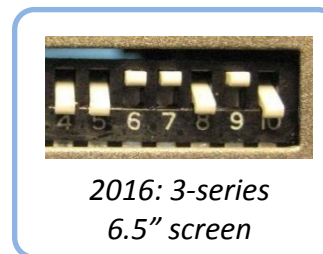

2016: 3-series
6.5" screen

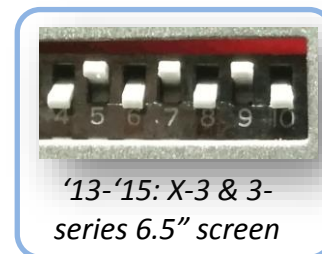

'13-'15: X-3 & 3-series
6.5" screen

Agreement: End user agrees to use this product in compliance with all State and Federal laws. NAV-TV Corp. would not be held liable for misuse of its product. If you do not agree, please discontinue use immediately and return product to place of purchase. This product is intended for off-road use and passenger entertainment only.

BMW12N-H Interface Installation (5 Series example)

1. The BMW12-N intercepts **two OEM harnesses in two locations**: the main radio quad-lock connector and the screen. You must gain access to both places for proper installation.
 - Access the rear of the screen by removing the dashboard panel (clips only) and then removing (2x) Torx T20 screws securing the screen to the sub-dash.



2. Disconnect the OEM screen LVDS video cable and connect it to the port on the BMW12-N labeled 'LCD-IN'.



3. Connect the provided LVDS Video Cable to the port on the BMW12-N labeled 'LCD-OUT' and the other end back to the screen.



4. To access the radio harness, remove the dash panel which sits in front on the radio stack (disc player), then remove and Torx screws securing the radio to the sub-dash. Pull the radio straight out and locate the quad-lock connector.

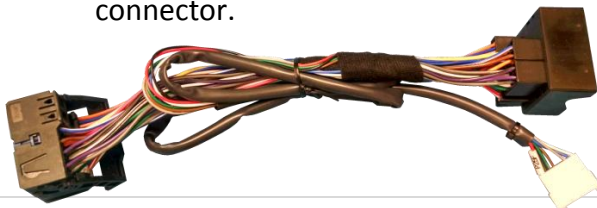

Agreement: End user agrees to use this product in compliance with all State and Federal laws. NAV-TV Corp. would not be held liable for misuse of its product. If you do not agree, please discontinue use immediately and return product to place of purchase. This product is intended for off-road use and passenger entertainment only.

5. Connect the provided **Interface Power Harness** to the provided **T-Harness** via the white 10-pin connector.

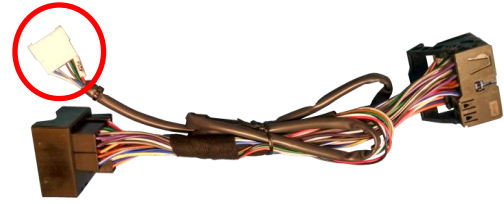

6. Connect your HDMI cable from the HDMI source to the port on the interface labeled 'HDMI IN'.



- a. Use the provided **Audio OUT Cable** for HDMI source audio out. *NOTE: connecting these white/red RCAs to the 'AUDIO IN' RCAs located among the Interface Power Harness will result in audio playback when 'AUX' is selected via the OEM BMW system.*



7. Install and run the reverse camera video source power and signal to the BMW12N-H interface location and connect to the RCA labeled 'CAMERA'. Power your camera with an ACC source or use the **violet wire** for reverse 12v (+) only. *NOTE: this wire outputs 500 mA MAX – do not use to supply power to more than 1 camera. Use this wire to trigger a relay if you're concerned with current supply.*
8. **Optional:** If installing a secondary camera or AUX video source, connect signal RCA to the RCA on the BMW12N-H interface labeled 'AVIN'.
9. After DIP switch settings have been set (see page 2), connect the 24-PIN power connector to the BMW12 interface labeled 'POWER CAN'. Proceed to **Menu Options** section if necessary (front camera settings, etc) or to **BMW12N-H Operation**.

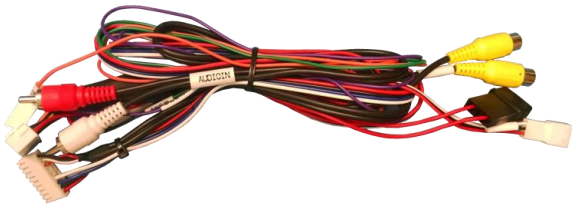

Menu Adjustments

Before you start:

- The IR-Eye must be connected
- Make sure the car's ignition is on and radio is on
- You must be in **Reverse Camera** mode **OR** **AUX Video** mode (see below):
 - **Reverse Camera Mode** adjusts Reverse Camera Settings
 - **AUX Video Mode** adjusts AUX Video Settings
- Press the **OK BUTTON 4 times** (numbers will display per press), then press **POWER**.
- The **OSD Menu** will appear on screen (auto-time out in about 5 seconds if no action occurs).



Return
(AUX VID
menu
control)

RVC Menu

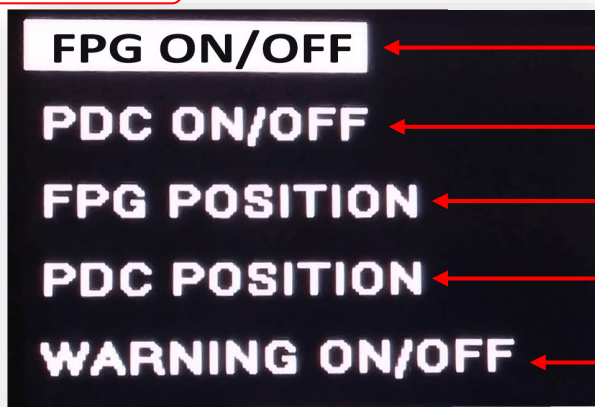

Functional Parking Guidelines ON/OFF

Parking Distance Control
ON/OFF (while in reverse)

Adjust FPG Position

Adjust PDC Position

'Safe to move?' ON/OFF

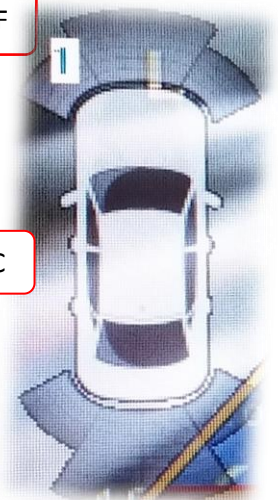

PDC

AUX
VIDEO
Menu

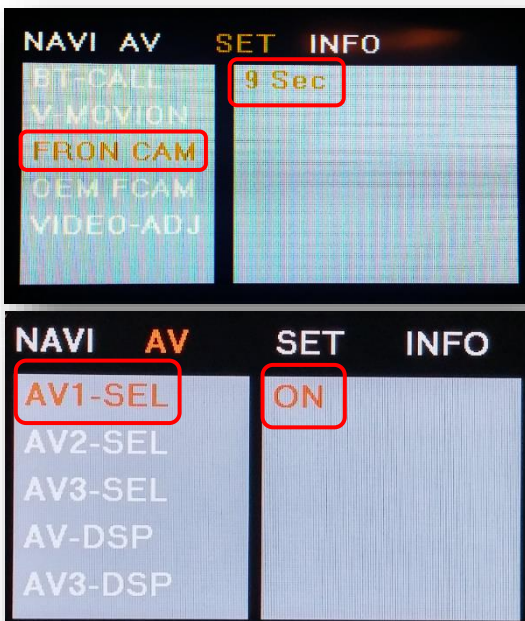

If adding a front camera OR Aux Video source:

1. Disconnect POWER/CAN Harness from interface
2. Place DIP SWITCH 1 in the DOWN position, reconnect power
3. Press and hold the iDRIVE knob '**MENU**' to activate the AUX screen
4. Press **OK** button on remote 4 times, then press **POWER**

SET – FRON CAM must be turned on if adding a *front camera* **and the user wishes for automatic front camera switching**. Options for 5, 7, 9 or 11 seconds are user-selectable for the length of time the front camera input stays active once the vehicle is placed out of reverse.

If the user wants only an AUX video input **without front camera**, set **AV1-SEL** to **ON**

Once finished with settings, place DIP SWITCH 1 back into the **UP position** and reset power to interface.

Agreement: End user agrees to use this product in compliance with all State and Federal laws. NAV-TV Corp. would not be held liable for misuse of its product. If you do not agree, please discontinue use immediately and return product to place of purchase. This product is intended for off-road use and passenger entertainment only.

HDMI Setup

In order to use the HDMI feature of this kit, it must be setup via the OSD menu first.



1. Put dip switch #1 in the **DOWN** position.
2. Activate the 'NAV INPUT' by holding the **HOME** button on the iDRIVE knob controller.
3. Once 'NAV INPUT' shows on the screen, on the remote press the **OK** **BUTTON 4 times**, then press **POWER**.
4. Navigate to the 'NAVI' section.
 - a. Select 'HDMI-SEL'
 - b. Choose 'HD95'
 - c. Press **MODE** on the remote to return
5. Navigate to the 'AV' section.
 - a. Select 'AV1-SEL'
 - b. Choose 'HDMI'
6. If the user desires **front camera timer**, set it up now through 'FRON CAM' under 'SET' and choose timer length. If adding front camera and no timer is desired, use DIP SWITCH #2 instead (only).
7. Replace dip switch #1 to the **UP** position.

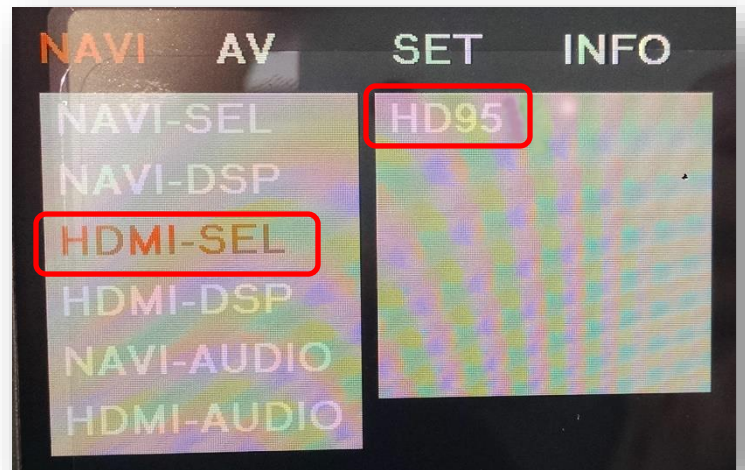

BMW12N-H Installation Diagram

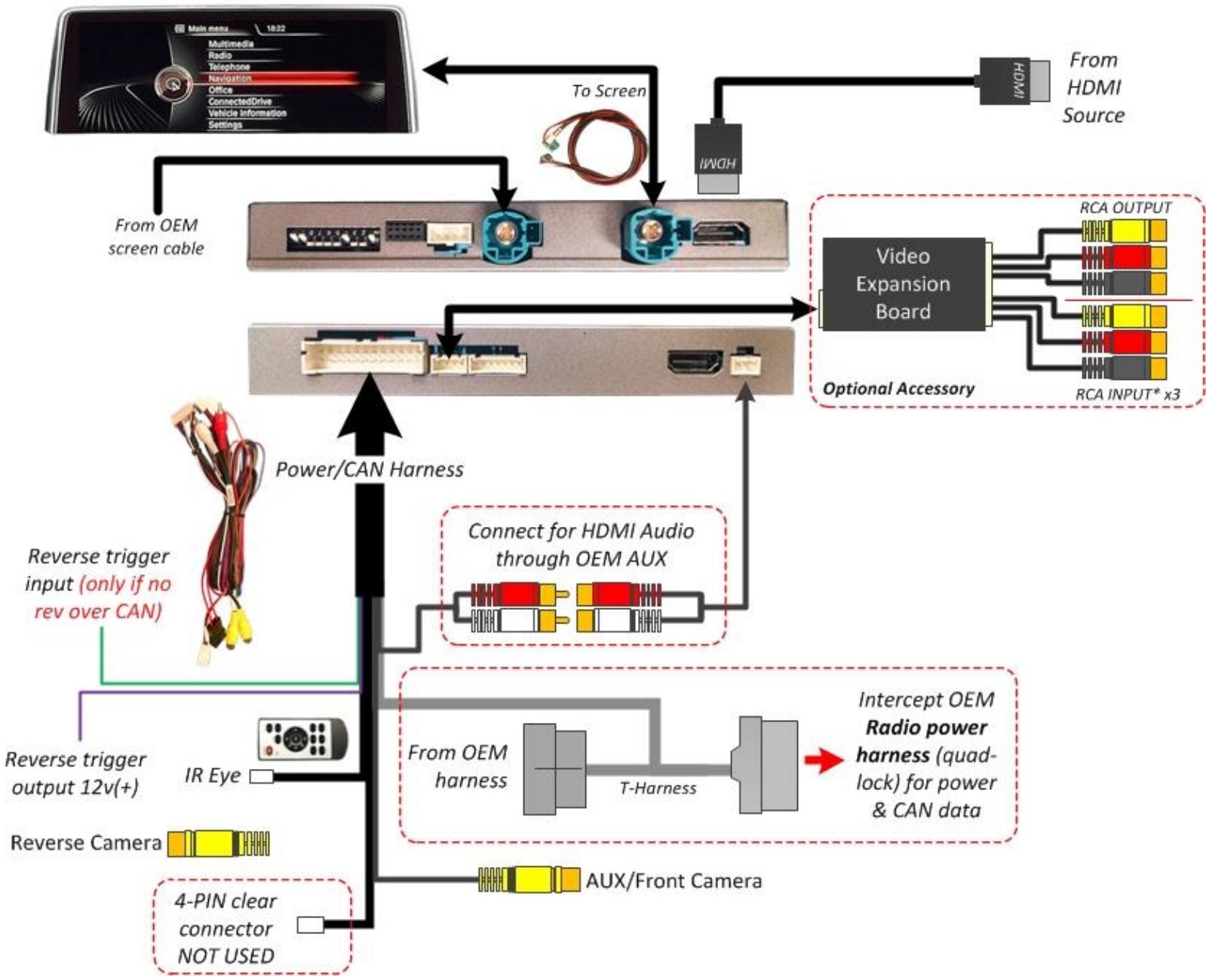

Agreement: End user agrees to use this product in compliance with all State and Federal laws. NAV-TV Corp. would not be held liable for misuse of its product. If you do not agree, please discontinue use immediately and return product to place of purchase. This product is intended for off-road use and passenger entertainment only.

BMW12N-H Operation

- Once all connections are made and dip switches are set properly, placing the vehicle in reverse will display the connected camera with dynamic guidelines for convenience.
- Additionally, see below for AUX/HDMI/Front camera activation using factory buttons.

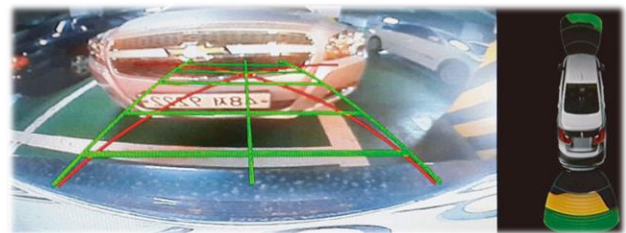
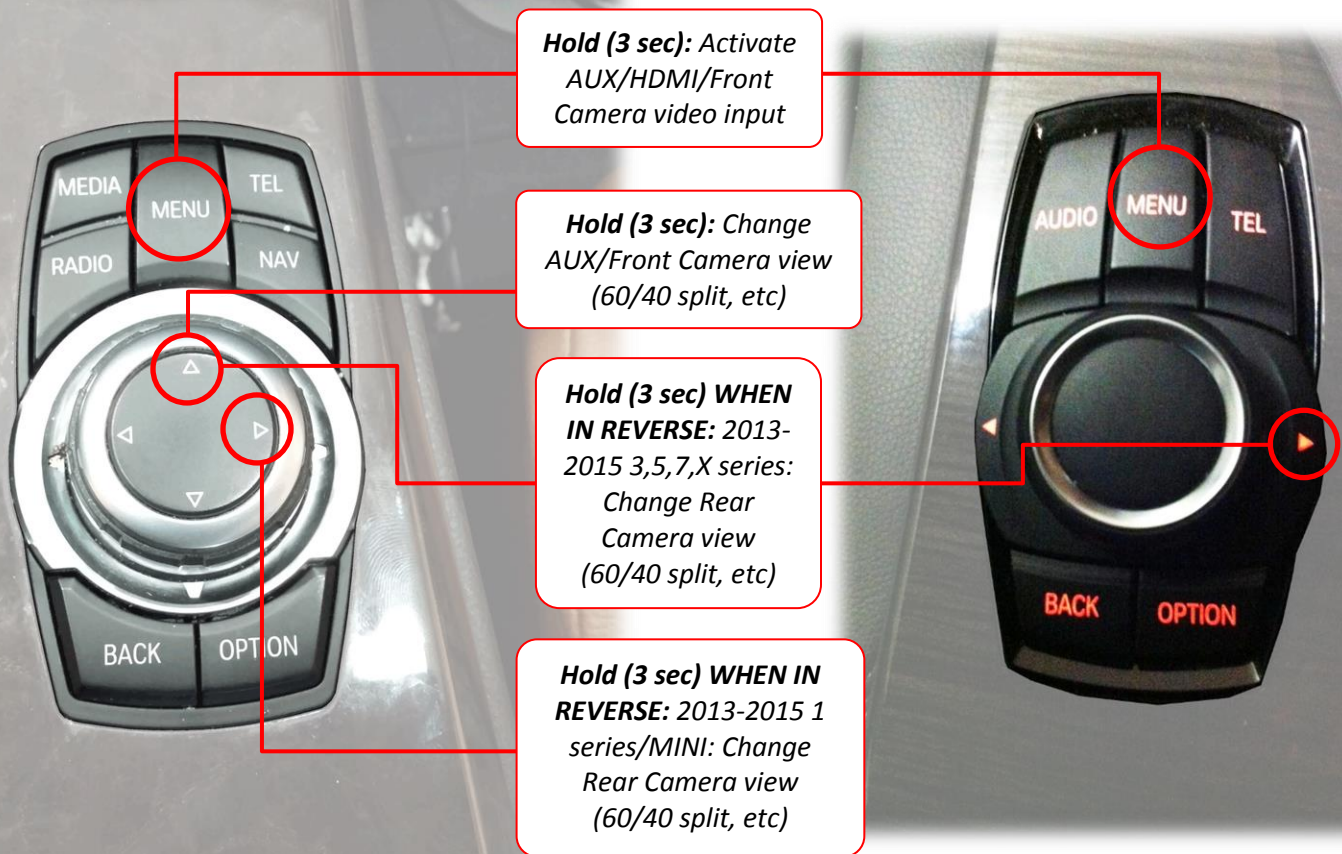

Agreement: End user agrees to use this product in compliance with all State and Federal laws. NAV-TV Corp. would not be held liable for misuse of its product. If you do not agree, please discontinue use immediately and return product to place of purchase. This product is intended for off-road use and passenger entertainment only.