

NAV-TV

INTERFACING THE FUTURE

3950 NW 120th Ave, Coral Springs, FL 33065 TEL 561-955-9770 FAX 561-955-9760

www.nav-tv.com info@nav-tv.com

BHM
10/17/18
NTV-DOC270

GM-LVDS

NTV-KIT780



Quick Reference
(LVDS) Video Cable connects at Screen
Power/CAN T-Harness connects at Screen
Unit requires Constant 12v
Do not power camera with reverse light. Use ACC or purple wire (through relay)

Overview

The GM-LVDS interfaces a backup camera input (and 1 additional video input) to the factory media screen in select GM vehicles equipped with either the **MYLINK** or **CUE** (8" only) media systems. *With additional parts, HDMI input or Navigation is available with this unit (available soon).* Audio integration uses the OEM AUX input if adding an A/V source).

Kit Content



Agreement: End user agrees to use this product in compliance with all State and Federal laws. NAV-TV Corp. would not be held liable for misuse of its product. If you do not agree, please discontinue use immediately and return product to place of purchase. This product is intended for off-road use and passenger entertainment only.

Interface Connectors

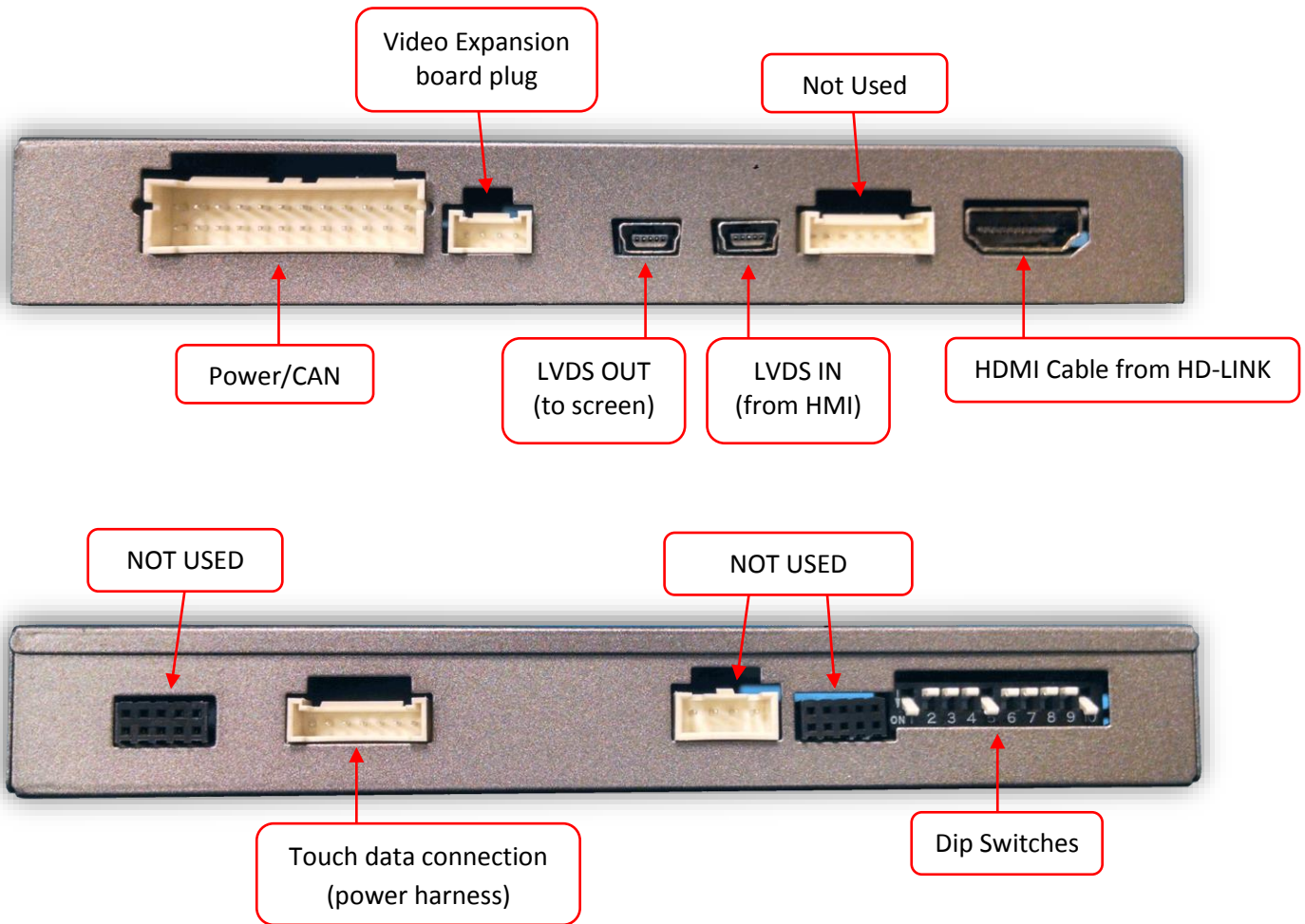

Dip Switch Settings* Configure prior to installation

Dip SW:	1	2	3	4	5	6	7	8	9	10
UP	NAV OFF	V1 OFF	V2 OFF	OEM camera	N/A Leave up	NAV OFF	N/A Leave up	Chevy/GMC	N/A Leave up	Keep Down
DOWN	ADDING NAV	V1 ON	V2 ON	Adding rear cam	N/A	ADDING NAV	N/A	Cadillac	N/A	Keep Down



***Note: If the dip switches are not configured prior to installation you must remove power to the unit prior to making adjustments to the dip switches. When power is reconnected after the dip switch adjustment the new settings will be stored into memory.**

Agreement: End user agrees to use this product in compliance with all State and Federal laws. NAV-TV Corp. would not be held liable for misuse of its product. If you do not agree, please discontinue use immediately and return product to place of purchase. This product is intended for off-road use and passenger entertainment only.

Screen Removal and Interface Installation (GM Truck)

THIS INTERFACE INSTALLS AT THE SCREEN, NOT AT THE HMI UNIT!

1. Remove the trim surrounding the main media screen using plastic tools and set it aside.
2. Remove (4x) 7mm screws securing the screen assembly to the sub-dash. Disconnect all connectors and set the screen aside.
3. The (2x) main connectors used for this integration kit are shown here (pictured right):
4. Locate the OEM plugs disconnected (from step 3) previously connected to the screen indicated here, and connect the provided **Chevy/GM T-Harness** or **Cadillac T-Harness** (only 1 is used per install) and **LVDS Input Cable**. The other end of these cables get connected to the **GM-LVDS** interface via the provided **Power/CAN Harness** and directly to the **LVDS IN** connector.

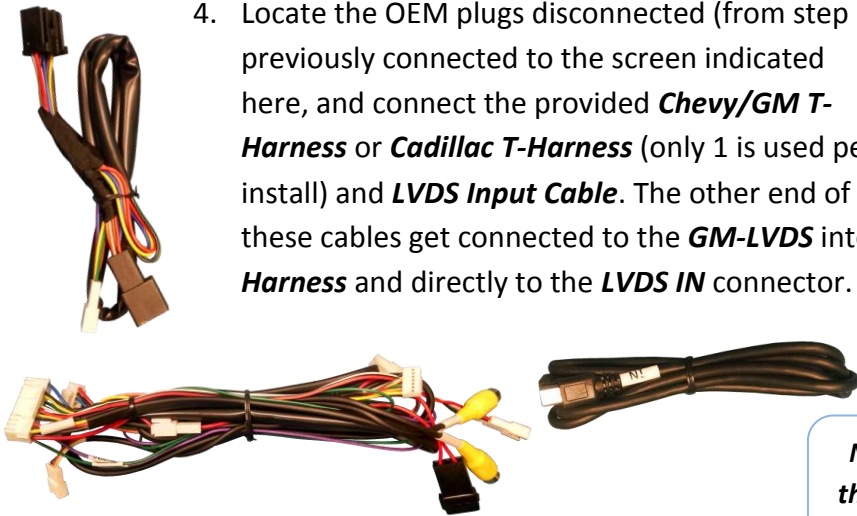
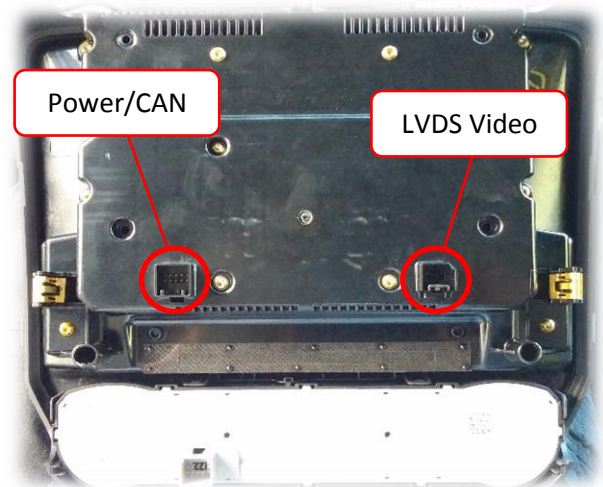

NOTE: if this vehicle has OEM Rear Seat Entertainment, these LVDS video cables must instead connect at the HMI module, and the 'IN' & 'OUT' must be swapped (at unit)

5. Connect the provided **LVDS Output Cable** from the 'video out' connector on the module, directly to the screen LVDS Video port (shown above). Make certain the connector is seated firmly.
6. Make the remaining connections to the module:
 - a. **Power/CAN** connection
 - b. **7-pin touch-data connector** to 'TOUCH' connector on module
7. The **purple wire** on the main power harness **outputs 12v (+) when in reverse only** (500mA max) and may be used for (single) camera power.
8. The **green wire** on the main power harness is used to **force the rear cam or AV1 video input RCA** (selectable – through OSD menu. See page 5 for menu options)
9. The clear **4-pin molex** connector (from main power harness) is not used.
10. Proceed to **GM-LVDS Operation** on page 4.



GM-LVDS Operation

- After all connections are made and **dip switches set properly**, start the vehicle. Placing the vehicle in reverse will show the connected rear camera, with dynamic guidelines overlaid onto the media screen.
- If adding a front camera, this must be activated in the OSD menu (see page 5) *or by setting DIP SWITCH #2 to ON*. Forcing this camera on at any time is performed by holding the **HOME** button or **MENU** button on the screen bezel for 3 seconds. **The module will cycle through video modes in this order: OEM>NAV>AV1>AV2>OEM, and will only show inputs that are active. Additionally, a single press of HOME, RADIO or MEDIA will bring you back to the OEM screen immediately.**
- Setting the **REVERSE WIRE** to AV1 in the AUX OSD menu and providing 12v (+) to the **green wire** will force the AV1 source.
- If the user wishes for the front camera to be set on a **timer** (front camera shows after leaving reverse gear, for preset amount of time), activate this feature in the OSD menu (see page 5).



Setting/Navigating OSD Menu

Before you start:

- The IR-Eye must be connected
- Make sure the car's ignition is on and radio is on
- You must be in **Reverse Camera** mode **OR AUX Video** mode (see below):
 - **Reverse Camera Mode** adjusts Reverse Camera Settings
 - **AUX Video Mode** adjusts AUX Video Settings
- Press the **OK BUTTON 4 times** (numbers will display per press), then press **POWER**.
- The **OSD Menu** will appear on screen (auto-time out in about 5 seconds if no action occurs).



Return
(AUX VID menu control)

RVC Menu

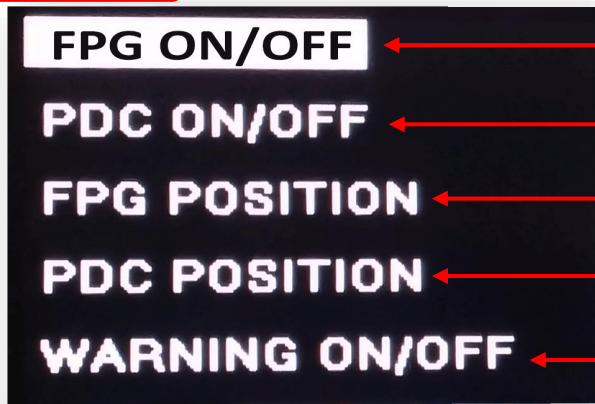

Functional Parking Guidelines ON/OFF

Parking Distance Control ON/OFF (while in reverse)

Adjust FPG Position

Adjust PDC Position

'Safe to move?' ON/OFF

PDC

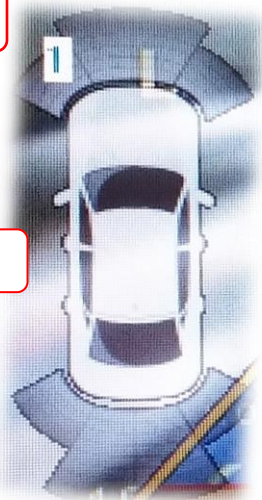

AUX VIDEO Menu

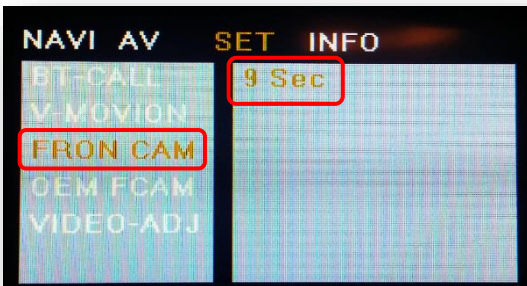

If adding a front camera OR Aux Video source:

1. Disconnect POWER/CAN Harness from interface
2. Place DIP SWITCH 1 in the DOWN position, reconnect power
3. Press and hold the **MENU** button on the dash to activate 'NAV input'
4. Press **OK** button on remote 4 times, then press **POWER**

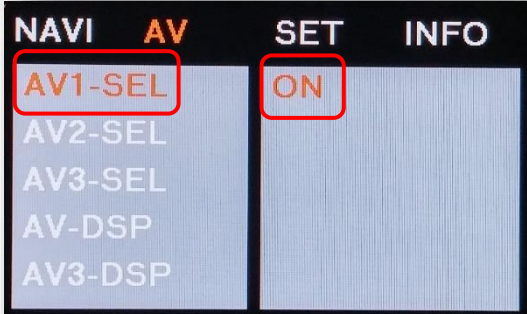

SET – FRON CAM must be turned on if adding a *front camera* **and the user wishes for automatic front camera switching**. Options for 5, 7, 9 or 11 seconds are user-selectable for the length of time the front camera input stays active once the vehicle is placed out of reverse.

If the user wants only an AUX video input **without front camera**, leave these options **OFF** and use DIP SWITCH 2 instead.

Once finished with settings, place DIP SWITCH 1 back into the **UP position** and reset power to interface.

Agreement: End user agrees to use this product in compliance with all State and Federal laws. NAV-TV Corp. would not be held liable for misuse of its product. If you do not agree, please discontinue use immediately and return product to place of purchase. This product is intended for off-road use and passenger entertainment only.

OSD Menu Options (continued)

BT-CALL

- **BT-CALL:** How a (OEM setup) Bluetooth phone call is handled while in AV/HDMI mode:
 - **ON** - When in AV/NAV mode, the unit will transition to the OEM screen when a Bluetooth phone call is active, then return when call is ended.
 - **OFF** - There is no screen transition when a BT call is active. The screen will remain in whatever mode it is currently on.

FRON CAM

- **V-MOVION:** N/A
- **FRON CAM:** Front camera timer (AV1) = without expansion board; (AV3) with expansion board
 - **5s, 7s, 9s, 11s:** Choose one (timer, in seconds), for the amount of time the *front camera (AV1)* shows after the vehicle is transitioned out of reverse gear
 - **OFF:** No timer activation

VIDEO-ADJ

- **OEM FCAM:** N/A
- **VIDEO ADJ:** Adjust video settings for AV1/HDMI/NAV, etc
- **AIR-CON:** Used on vehicles that display the HVAC/volume information on the screen whenever an adjustment is made.
 - **ON:** When in AV/HDMI mode, the screen will transition to the OEM screen to display the HVAC/volume adjustment, then auto transition back to AV mode.
 - **OFF:** When in AV/HDMI mode, the screen will remain while HVAC/volume adjustments are made.

AIR PIP ON

- **REAR MODE:** Used to determine operation when the vehicle is placed into reverse.
 - **ON:** RVC dip switch (#4) dependent (follows DS #4).
 - **OFF:** The unit will ignore the reverse gear/wire. (No screen transition in AV or OEM)
 - **DIP 4 ON: Aftermarket camera input:** In AV/HDMI or OEM, the screen will transition to the RVC input when reverse is detected. Will display any extra overlay info, PDC, active guidelines.
 - **DIP 4 OFF: OEM equipped camera:** In AV/HDMI the unit will transition into the OEM screen when reverse is detected.

- **REVERSE WIRE:** Providing 12v (+) to the **green wire** acts as an external activation for the selected input (connect through toggle switch, SVS-6, etc).
 - **REAR MODE:** Follows the REAR MODE operation (with guideline overlay and any additional options)
 - **REAR:** Displays the RVC input video in its raw form (no extra overlays)
 - **AV1:** Displays AV1 input

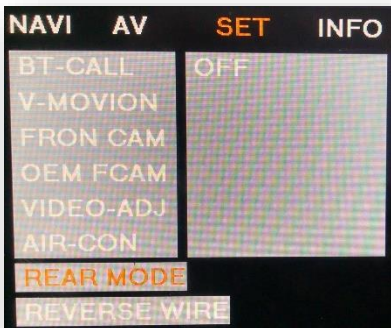

Adding HD-LINK Adapter (HDMI Input)

Follow the instructions below when adding the HDMI adapter (HD-LINK) to enable HDMI input to the OEM screen:



1. Put dip switch #1 in the **DOWN** position.
2. Activate the 'NAV INPUT' by **holding** the 'HOME' or 'MENU' button on the dashboard.
3. Once 'NAV INPUT' shows on the screen, on the remote press the **OK BUTTON 4 times**, then press **POWER**.
4. Navigate to the 'NAVI' section.
 - a. Select 'HDMI-SEL'
 - b. Choose 'HD95E'
 - c. Press **MODE** on the remote to return and exit the OSD menu (or let it time out).
5. Replace dip switch #1 to the **UP** position.
6. Connect the **black wire** to ground (-) and the **red wire** to ACC power (+) from the main power connector on the **HD-LINK** adapter. The RCA's on this plug provide audio from the HDMI source.

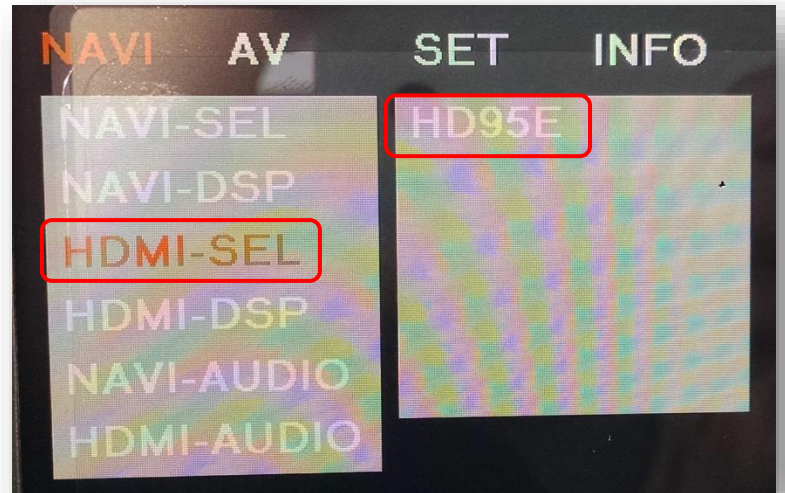

GM-LVDS Connection Diagram

NOTE: if this vehicle has OEM Rear Seat Entertainment, the LVDS video cables must instead connect at the HMI module, and the 'IN' & 'OUT' must be swapped (at unit)

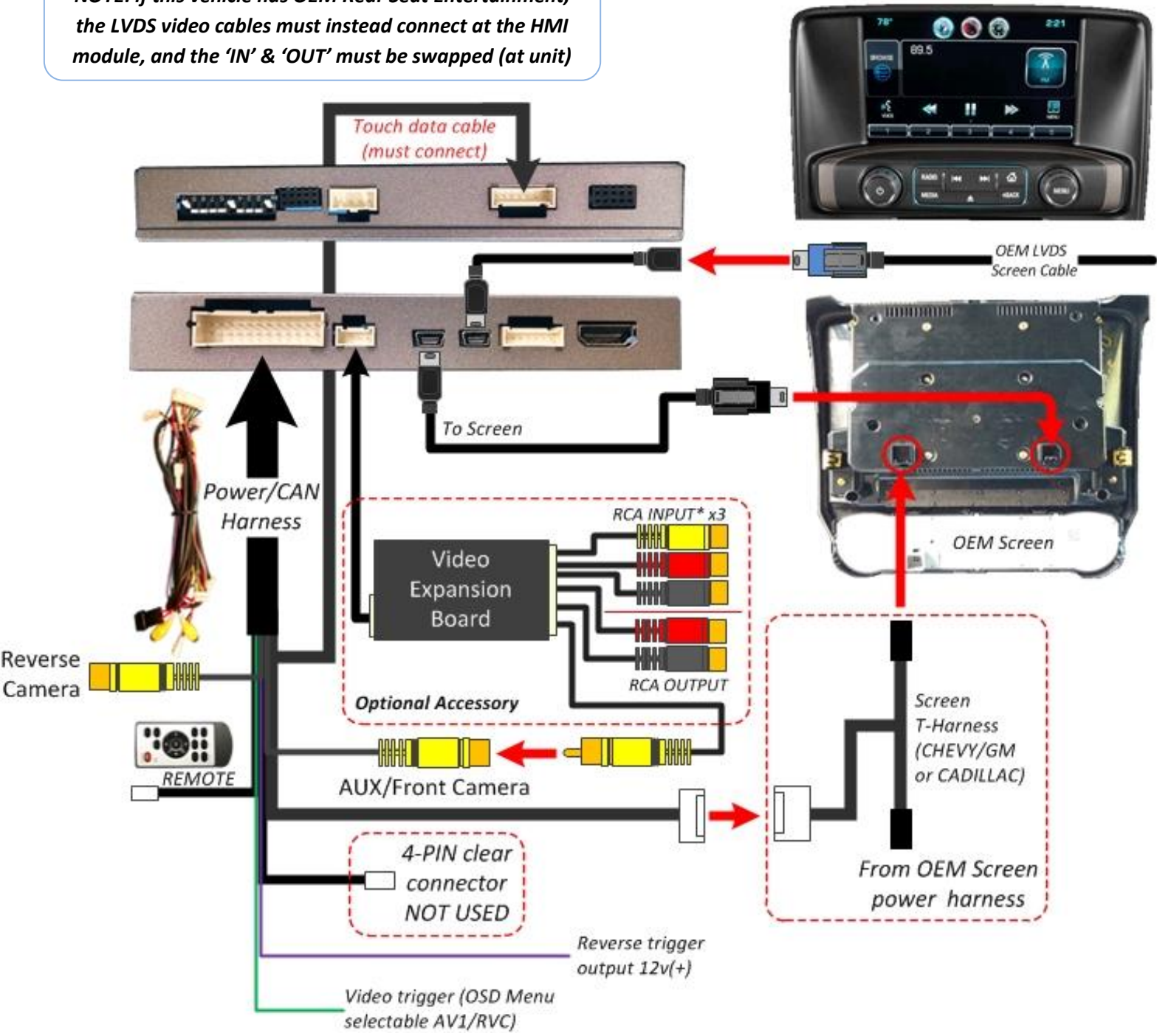

Agreement: End user agrees to use this product in compliance with all State and Federal laws. NAV-TV Corp. would not be held liable for misuse of its product. If you do not agree, please discontinue use immediately and return product to place of purchase. This product is intended for off-road use and passenger entertainment only.

GM-LVDS FAQ

1. ***I've installed this interface properly, now I have a black screen all the time.***
 - a. Make certain the IN and OUT LVDS video cables are connected in the proper location (at the screen and proper direction), and seated fully. The 'OUT' cable should go directly to the screen, and the 'IN' cable is really just an extension, and should be connected from the OEM LVDS cable previously connected to the screen.
 - b. This kit connects at the screen and not the HMI unit.
 - c. Make sure the provided 'OUT' connector at the screen is seated fully into the screen (may need to wiggle it in or even shave some rubber from the connector).
 - d. Make certain the 5-pin 'TOUCH' connector is connected to the 'TOUCH' port and not the 'RGB IN' port.
 - e. Verify the LEDs on the inside of the unit are twinkling with the key on. If not, check the fuse on the **red** power line going into the main connector of the unit.
2. ***I have OEM screen and reverse image, but my touch screen no longer works with this kit connected.***
 - a. You must connect the 7-pin **touch-data cable** to the module at the port labeled 'TOUCH'.
3. ***Nothing happens when I place the vehicle in reverse – it stays on the OEM screen.***
 - a. Be certain DIP SWITCH #4 is ON (down). This enables the RVC port on the module.
 - b. Make sure DIP SWITCH #8 is set properly for the vehicle you're working on.
4. ***With this kit connected, the touch screen is not working properly (not exact).***
 - a. Make sure DIP SWITCH #8 is set properly for the vehicle you're working on.
 - b. If this is a MALIBU vehicle, you need the MALIBU kit instead of this kit, the touch data is different than the rest of the compatible GM vehicles.